

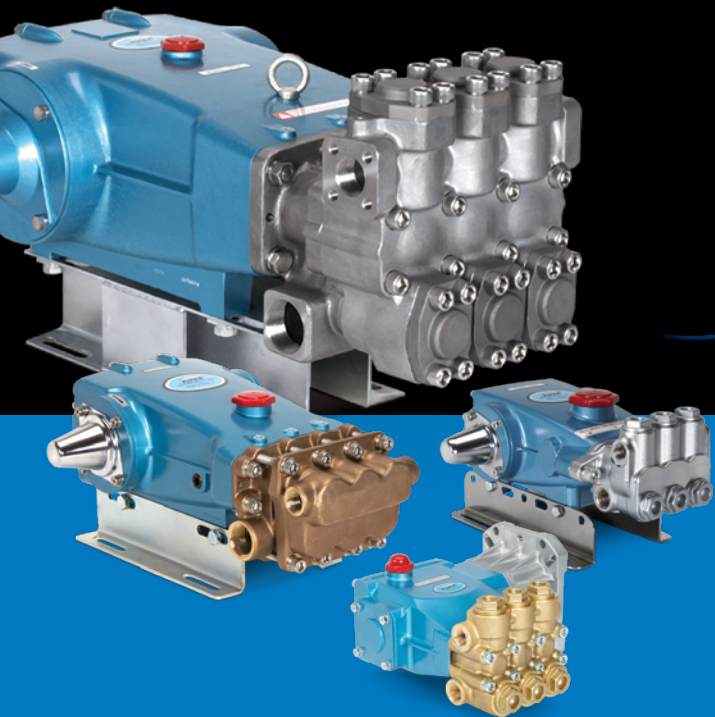

# Pump Catalog

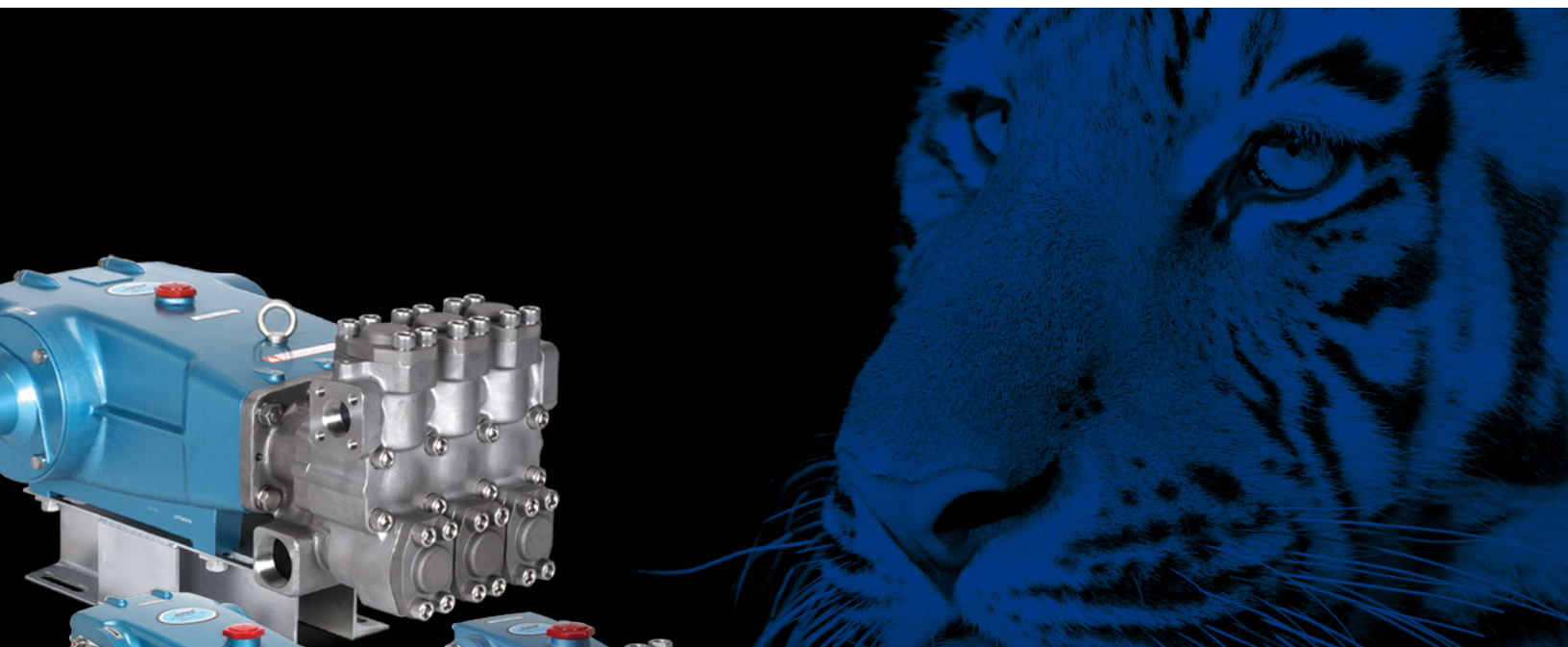

Product Quality, Reliability and Support You Expect

[www.catpumps.com](http://www.catpumps.com)

# World Leader in Triplex Reciprocating High-Pressure Pumps

Cat Pumps designs and builds products to the highest quality level for one major reason: our customers depend on our products to keep their equipment running. Every design detail is optimized for long product life and reliable performance.

Cat Pumps embraces a zero defect manufacturing philosophy. Stringent process controls result in highly repeatable processes, yielding the highest level of product reliability. Cat Pumps commitment to quality is legendary within the industry, earning the trust from customers worldwide. When it needs to run, make it Cat Pumps.

## Product Performance Range

A wide range of pump options are available, including a variety of products that meet various industry certifications and directives.

- Flow: 0.13 to 240 gpm (0.49 to 908 lpm)
- Pressure: 100 to 10,000 psi (6.9 to 689 bar)
- RPM: 100 to 3450
- Liquid Temperature: -10° to 240°F (-23° to 115°C)
- Manifold Materials: Brass, Nickel Aluminum Bronze, 304 and 316 Stainless Steel, Duplex Stainless Steel
- Drives: Electric, Engine, Hydraulic, Pneumatic

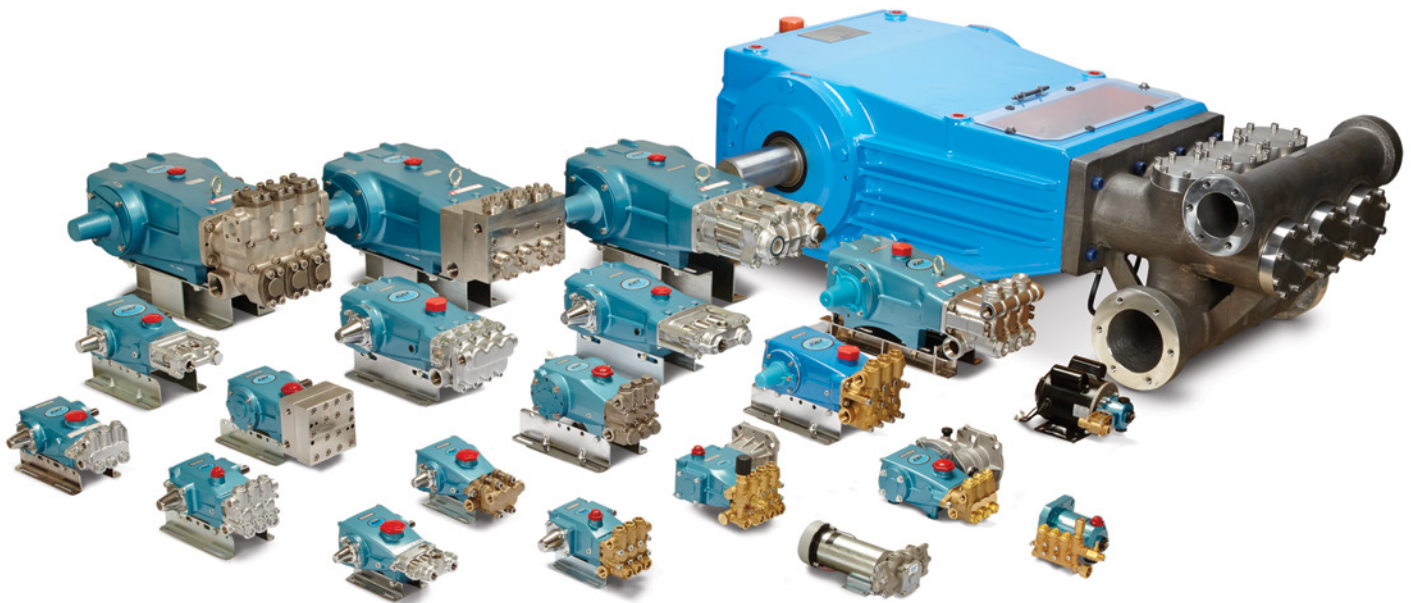

# Product Ordering

## Using This Catalog

The pump sections of this catalog are organized by drive type/flow rate/manifold materials: brass, 316 stainless steel, duplex stainless steel and nickel aluminum bronze. The model numbers listed represent standard pumps equipped with Buna-N seals and O-rings, except for specialty pumps, such as CO<sub>2</sub>, TEG and portable extractor, which are fitted with unique seals for the application.

Standard Buna-N pump seals and/or O-rings can be changed by adding a suffix to the standard model number that represents the desired new seal material.

Optional Seal and O-Ring Configurations		
MATERIAL CODE	DESCRIPTION	PUMP MODEL SUFFIX
FPM	Fluorocarbon (Viton®) seals and O-rings, chemical resistance, rated to 180° F (82° C)	.0110
EPDM	Ethylene Propylene Diene Monomer seals and O-rings	.0220
HT	High-temperature seal for plunger pump high pressure seals	.3000
	High-temperature V-HOT cup for piston pumps, rated to 190° F (87° C)	.3000
STHT	Special Teflon® high temperature low and high pressure seals, rated to 200° F (93° C)	.3400
PTFE	Pure Polytetrafluoroethylene (Teflon®) seals and Buna-N O-rings	.0700
	Pure Polytetrafluoroethylene (Teflon®) seals and FPM O-rings	.0710
IPFE	Pure Polytetrafluoroethylene (Teflon®) seals and Isolast O-rings	.0770
NBRS	Buna-N silicone free seals and O-rings	.6000
ST4	Special blend Polytetrafluoroethylene high and low pressure seals, FPM O-Rings, FPM crankcase elastomer	.44101

Viton® and Teflon® are registered trademarks of DuPont Dow Elastomers.

## Example

Pump model 3535 can be changed from Buna-N to either FPM or EPDM. To convert pump model 3535 from Buna-N seals and O-rings to FPM (Viton®), add the suffix (.0110) to the standard pump model number (3535.0110). Use this new number when ordering the pump.

Cat Pumps configures a number of pumps for special applications and certifications such as ATEX, CO<sub>2</sub>, TEG, Flushed, High-Temp and others. Please contact Cat Pumps directly at (763) 780-5440 for more information.

## Table of Contents

<b>Direct Drive Plunger Pumps</b>	Page 6	<b>Piston Pumps</b>	Page 14
Hollow Shaft: Brass Manifold	6 – 7	<b>Specialty Pumps</b>	15
Hollow Shaft: 316 Stainless Steel	7	Flushed Manifold Pumps	15
Gearbox: Brass Manifold	7	High Temperature Pumps	16
Gearbox: 316 Stainless Steel Manifold	8	Triethylene Glycol (TEG) Pumps, 240° F	16
Bell Housing: Brass Manifold	8	Washout Resistant Pumps	17
Bell Housing: 316 Stainless Steel Manifold	8	Liquid CO <sub>2</sub> Pumps	17
Bell Housing: 316 Nickel Aluminum Bronze Manifold	9	ATEX Pumps	18
<b>Belt Drive Plunger Pumps</b>		1CX Series Compact Misting Pumps	18
Brass and 304 Stainless Steel	10 – 11	1XP Series Portable Extractor Pumps	19
316 Stainless Steel	12	<b>Centrifugal Pumps</b>	20
Duplex Stainless Steel	13	<b>Accessories</b>	21
Nickel Aluminum Bronze	13	<b>Custom Pumping Systems</b>	22 – 23

# Selecting your pump

## Plunger Pumps (0.13 – 240 gpm, 100 – 10,000 psi)

Plunger pumps utilize spring-loaded closed and hydraulically opened inlet and discharge valves to direct flow through the pump manifold. At the beginning of the stroke, the plunger displaces the liquid in the manifold chamber, forcing the discharge valve open. When the plunger reaches the end of the stroke, the discharge valve closes. As the plunger rod begins its backward stroke, the inlet valve opens to allow more liquid into the manifold chamber, thereby keeping a smooth forward flow of liquid.

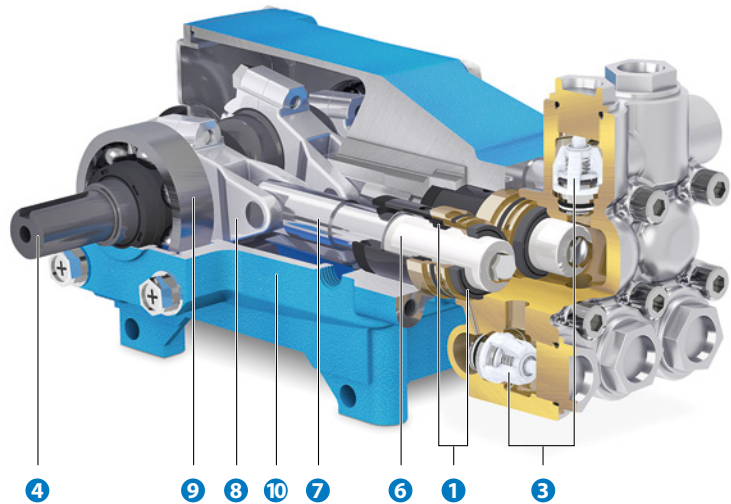

## XP Series Pumps (0.5 – 2 gpm, 100 – 1,000 psi)

In XP series pumps, fluid enters the inlet port and flows through the drive-end, lubricating the connecting rods and plunger rods as it passes to the inlet valves. Both inlet and discharge valves are spring-loaded closed and hydraulically opened, similar to plunger pumps, however, they utilize a flow-through ceramic plunger design. The continuous forward flow characteristics in conjunction with the packing design of plunger pumps result in improved suction capabilities as well as extended seal life.

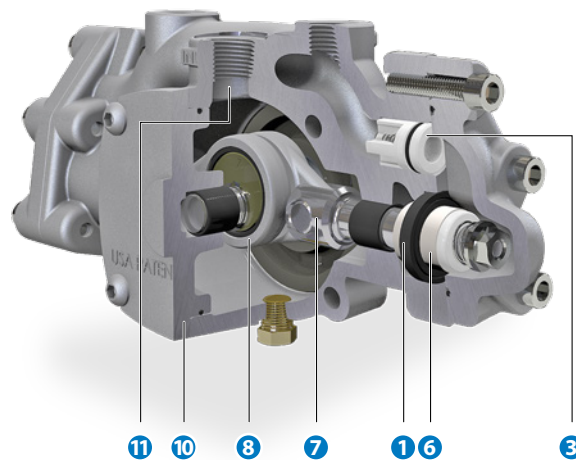

## Features

- 1 Specially formulated, Cat Pumps exclusive high pressure and low pressure seals offer unmatched performance and seal life.
- 2 100% wet cup/seal design adds to service life by allowing pumped fluids to cool and lubricate the elastomers on both sides.
- 3 Stainless steel valves, seats, and springs provide corrosion-resistance, positive seating, and long life.
- 4 Chrome-moly crankshaft provides unmatched strength and surface hardness for long life.
- 5 The patented stepped piston rod with hard chrome-plated sleeve provides a durable wear surface and easy wet end servicing.
- 6 Precision-polished, solid ceramic plungers provide maximum resistance to corrosion and abrasion, extending seal life.

## Piston Pumps (3.0 – 60 gpm, 100 – 1,500 psi)

The design of the piston pump is for the fluid to move continually in one, smooth forward direction. This design allows greater suction capabilities and reduces the risk of cavitation provided the pump is properly primed. At the beginning of the stroke, the mechanically actuated inlet valve (and piston) will close. As the piston rod moves forward, the liquid is forced out through the discharge valves. Simultaneously, the liquid enters the pump inlet and flows in behind the inlet valve. As the piston rod begins the backward stroke, the inlet valve mechanically opens, permitting the liquid to continue its flow forward through the piston into the discharge chamber.

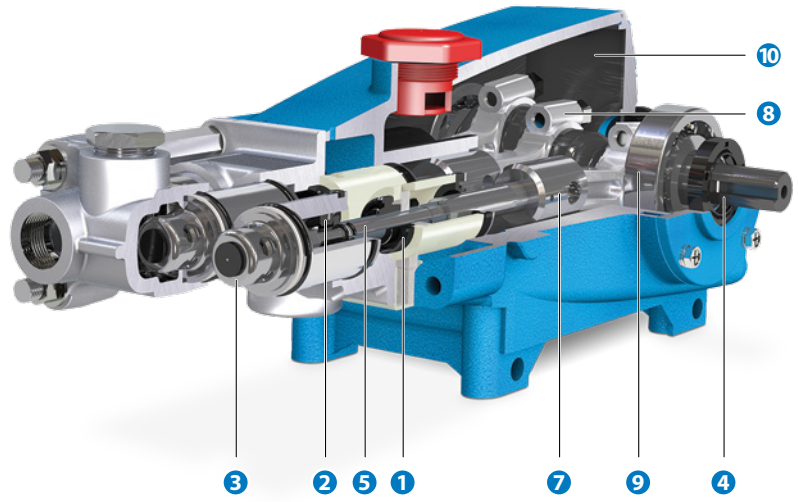

## SF Series Pumps (0.5 – 5 gpm, 100 – 3,500 psi)

In SF series pumps, both the inlet and discharge valves are spring-loaded closed and hydraulically opened, similar to plunger pumps, however, they have a flow-through ceramic plunger design. The continuous forward flow characteristic of piston pumps is utilized in conjunction with the packing design of the plunger pumps. These features give SF pumps both strong suction capabilities and higher pressure performances.

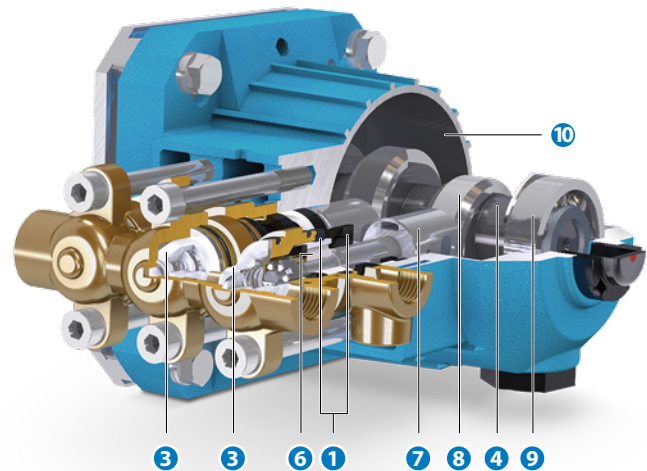

- 7 The high strength stainless steel plunger rods have a 360° supported crosshead providing uncompromising plunger rod alignment.
- 8 Matched oversized connecting rods are made of high strength material with exceptional bearing quality.
- 9 Oversized ball bearings or tapered roller bearings provide extended bearing life.

- 10 High Strength, light weight die cast aluminum crankcase with splash oil design allows operation at speeds as low as 100 RPM.
- 11 Patented greaseless design uses water from inlet as lubrication, eliminating the maintenance and mess of grease or oil.

# Plunger Pumps

## DIRECT DRIVE, HOLLOW SHAFT, BRASS MANIFOLD

Electric Motor, 5/8" and 3/4", 56C Face



Model 4DX10ER

PUMP MODEL	MAXIMUM FLOW		MAXIMUM PRESSURE		RPM	SHAFT	POWER	
	gpm	lpm	psi	bar			hp	kW
4DX03ELR	0.3	1.1	2000	138	1725	5/8"	0.24	0.18
4DX10ER	1.0	3.8	2000	138	3450	5/8"	1.37	1.02
4DX15ER	1.5	5.7	2000	138	3450	5/8"	2.05	1.53
4DX20ER	2.0	7.6	2000	138	3450	5/8"	2.74	2.04
4SP21ELR	2.1	7.9	2000	138	1750	5/8"	2.9	2.16
2SF22ES	2.2	8.4	2000	138	3450	5/8"	3.0	2.2
4DX27ER	2.7	10.3	2000	138	3450	5/8"	3.7	2.76
4SP29ELR	2.85	10.8	1200	83	1725	5/8"	2.4	1.8
4DX30ER	3.0	11.4	2000	138	3450	5/8"	4.11	3.07
2SF30GES	3.0	11.4	2000	138	3450	3/4"	4.1	3.0
2SF35ES	3.5	13.3	1500	103	3450	5/8"	3.6	2.7
2SF35GES	3.5	13.3	2000	138	3450	3/4"	4.8	3.5
2SFP500EL	5.0	19.0	500	34.5	1750	5/8"	1.7	1.3

Note: Pumps rated at 3450 rpm can operate at 1725 rpm, reducing flow by 50%.

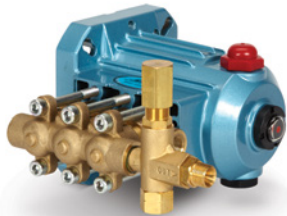

Model 2SF22ES

## DIRECT DRIVE, HOLLOW SHAFT, BRASS MANIFOLD

Electric Motor, 1 1/8", 184TC Face

PUMP MODEL	MAXIMUM FLOW		MAXIMUM PRESSURE		RPM	SHAFT	POWER	
	gpm	lpm	psi	bar			hp	kW
4SF32ELS	3.2	12.1	3500	241	1725	1 1/8"	7.7	5.7
4SF40ELS	4.0	15.2	3500	241	1725	1 1/8"	9.6	7.1
4SF45ELS	4.5	17.1	3000	207	1725	1 1/8"	9.2	6.8
4SF50ELS	5.0	19.0	3000	207	1725	1 1/8"	10.3	7.6

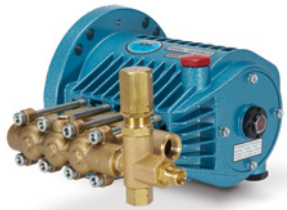

Model 4SF45ELS

## DIRECT DRIVE, HOLLOW SHAFT, BRASS MANIFOLD

Engine, 3/4"

PUMP MODEL	MAXIMUM FLOW		MAXIMUM PRESSURE		RPM	SHAFT	HP
	gpm	lpm	psi	bar			Typical Gas Engine*
4DNX25GSI	2.5	9.5	3000	207	3450	3/4"	6.5
4DNX27GSI	2.7	10.3	3000	207	3450	3/4"	8
3DX29GSI	2.9	11.0	2500	172	3450	3/4"	6.5
2SF35GS	3.5	13.3	2000	138	3450	3/4"	8

\*Consult engine manufacturer for actual torque available at required speed.



Model 4DNX25GSI

# Plunger Pumps

## DIRECT DRIVE, HOLLOW SHAFT, BRASS MANIFOLD Engine, 1"

PUMP MODEL	MAXIMUM FLOW		MAXIMUM PRESSURE		RPM	SHAFT	HP Typical Gas Engine*
	gpm	lpm	psi	bar			
66DX30G1I	3.0	11.4	4000	276	3450	1"	13
4SPX32G1I	3.2	12.2	3000	207	3450	1"	9
66DX35G1I	3.5	13.3	4000	276	3450	1"	13
66DX40G1I	4.0	15.2	4000	276	3450	1"	16
4SF45GSI	4.5	17.1	3000	207	3450	1"	13
4SF50GSI	5.0	19.0	3000	207	3450	1"	16

\*Consult engine manufacturer for actual torque available at required speed.



Model 66DX40G1I

## DIRECT DRIVE, HOLLOW SHAFT, 316 STAINLESS STEEL MANIFOLD Electric Motor, 5/8", 56C Face

PUMP MODEL	MAXIMUM FLOW		MAXIMUM PRESSURE		RPM	SHAFT	POWER	
	gpm	lpm	psi	bar			hp	kW
2SF05SEEL	0.5	1.9	1200	83	1725	5/8"	0.4	0.3
2SF10SEEL	1.0	3.8	1200	83	1725	5/8"	0.8	0.6
2SF15SEEL	1.5	5.7	1200	83	1725	5/8"	1.2	0.9
2SF22SEEL	2.2	8.4	1200	83	1725	5/8"	1.8	1.3
2SF25SEEL	2.5	9.5	1200	83	1725	5/8"	2.1	1.5
2SF29SEEL	2.85	10.8	1200	83	1725	5/8"	2.3	1.7
2SF35SEEL	3.5	13.3	1200	83	1725	5/8"	2.9	2.1
2SF42SEEL	4.2	15.9	1000	69	1725	5/8"	2.9	2.1

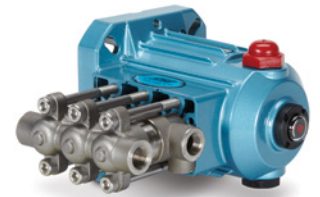

Model 2SF22SEEL

## DIRECT DRIVE, HOLLOW SHAFT GEARBOX, BRASS MANIFOLD Engine, 3/4" and 1"

PUMP MODEL	MAXIMUM FLOW		MAXIMUM PRESSURE		RPM		SHAFT	HP Typical Gas Engine*
	gpm	lpm	psi	bar	Pump	Engine		
740G1	2.8	10.6	5000	345	1700	3465	1"	13
3CP1120G	3.5	13.3	2200	152	1420	3600	3/4"	8
5CP3160CSSG1	4.0	15.2	3500	241	1627	3320	1"	13
60G1	4.2	16.0	4000	276	1570	3200	1"	18
5CP3120CSSG1	4.5	17.1	3500	241	1645	3353	1"	16
700G1	4.5	17.1	5000	345	1700	3465	1"	20
5CP5135CSSG1	5.0	19.0	3500	241	1515	3090	1"	16
5CP5140CSSG1	5.5	20.9	3500	241	1500	3060	1"	18
5CP6120CSSG1	6.7	25.5	1600	110	1570	3200	1"	8
56G1	8.0	30.4	2500	172	1760	3600	1"	16
5CP6190G1	8.7	33.1	1200	83	1570	3200	1"	11
7CP6110G1	10.0	38.0	2000	138	1667	3400	1"	18
7CP6170G1	12.0	45.4	1800	124	1600	3264	1"	16

Note: All 1" Gearboxes are also available in 1 1/8" size (G118)

\*Consult engine manufacturer for actual torque available at required speed.



Model 56G1



Model 5CP3120CSSG1

# Plunger Pumps

## DIRECT DRIVE, HOLLOW SHAFT GEARBOX, 316 STAINLESS STEEL MANIFOLD

Engine, 3/4" and 1"



Model 7CP6111G1

PUMP MODEL	MAXIMUM FLOW		MAXIMUM PRESSURE		RPM		SHAFT	HP Typical Gas Engine*
	gpm	lpm	psi	bar	Pump	Engine		
3CP1241G	3.0	11.4	2000	138	1410	3600	3/4"	5
3CP1211G	3.8	14.4	1500	103	1330	3400	3/4"	5
5CPQ6241CSG1	4.0	15.2	2000	138	1760	3600	1"	8
781G1	4.5	17.1	5000	345	1700	3465	1"	20
5CPQ6221G1	7.4	28.0	1200	83	1760	3600	1"	8
7CP6111G1	10.0	38.0	2000	138	1667	3400	1"	18

Note: All 1" Gearboxes are also available in 1 1/8" size. (G118).  
\*Consult engine manufacturer for actual torque available at required speed.

## DIRECT DRIVE, SOLID SHAFT, BRASS MANIFOLD

Electric Motor - Bell Housing

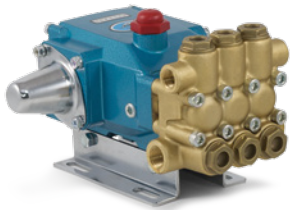

Model 3CP1120

PUMP MODEL	MAXIMUM FLOW		MAXIMUM PRESSURE		RPM	SHAFT	POWER	
	gpm	lpm	psi	bar			hp	kW
5CP4110CSS	2.2	8.4	4000	276	1725	20 mm	6.0	4.4
3CP1130	2.4	9.1	2200	138	1725	16.5 mm	3.6	2.7
5CP3105CSS	2.5	9.5	3500	241	1725	20 mm	6.0	4.4
5CP4112CSS	2.7	10.3	4000	276	1725	20 mm	7.4	5.5
740	2.8	10.6	5000	345	1700	24 mm	9.6	7.2
5CP4114CSS	3.2	12.1	4000	276	1725	20 mm	8.8	6.5
3CP1140	3.6	13.7	2200	152	1725	16.5 mm	5.4	4.0
5CP3110CSS	3.6	13.7	3500	241	1725	20 mm	8.6	6.4
5CP4116CSS	3.8	14.4	4000	276	1725	20 mm	10.4	7.8
5CP2140WCS	4.0	15.2	2500	172	1725	20 mm	6.8	5.1
3CP1120	4.2	16.0	2200	152	1725	16.5 mm	6.3	4.7
5CP4118CSS	4.2	16.0	4000	276	1725	20 mm	11.5	8.6
5CP3160CSS	4.3	16.3	3500	241	1725	20 mm	10.3	7.6
5CP4120CSS	4.5	17.1	4000	276	1725	20 mm	12.3	9.1
60	4.7	17.9	4000	276	1725	24 mm	12.9	9.5
700	4.7	17.9	5000	345	1750	24 mm	16.1	12.0
5CP3120CSS	4.8	18.2	3000	207	1725	20 mm	9.9	7.3
5CP2150W	5.0	19.0	2000	138	1725	20 mm	6.8	5.1
5CP5120	6.0	22.8	2500	172	1725	20 mm	10.3	7.6
5CP5140CSS	6.7	25.4	3000	207	1750	20 mm	13.8	10.3
5CP6120	7.4	28.1	1200	83	1725	20 mm	6.1	4.5
56	8.0	30.4	2500	172	1760	24 mm	13.7	10.1
5CP6190	10.0	38.0	1200	83	1800	20 mm	8.2	6.1
7CP6110	10.5	39.9	2000	138	1725	24 mm	14.4	10.6

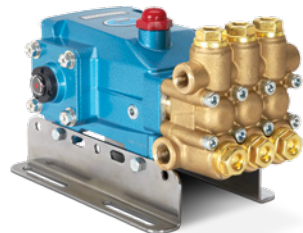

Model 5CP3160CSS

## DIRECT DRIVE, SOLID SHAFT, 316 STAINLESS STEEL MANIFOLD

Electric Motor - Bell Housing



Model 3CP1231

PUMP MODEL	MAXIMUM FLOW		MAXIMUM PRESSURE		RPM	SHAFT	POWER	
	gpm	lpm	psi	bar			hp	kW
3CP1231	2.3	8.7	2000	138	1725	16.5 mm	3.2	2.3
784	2.8	10.6	5000	345	1700	24 mm	9.6	7.2
3CP1241	3.6	13.7	2000	138	1725	16.5 mm	4.9	3.6
5CPQ6241CS	4.0	15.2	2000	138	1725	20 mm	5.5	4.1
3CP1221	4.2	16.0	2000	138	1725	16.5 mm	5.8	4.3
781	4.7	17.8	5000	345	1750	24 mm	16.1	12.0
5CP6251	5.0	19.0	2000	138	1725	20 mm	6.8	5.1
5CPQ6221	7.4	28.0	1200	83	1725	20 mm	6.1	4.5
7CP6111	10.5	39.9	2000	138	1725	24 mm	14.4	10.6



# Plunger Pumps

## DIRECT DRIVE, SOLID SHAFT, NICKEL ALUMINUM BRONZE MANIFOLD Electric Motor - Bell Housing

PUMP MODEL	MAXIMUM FLOW		MAXIMUM PRESSURE		RPM	SHAFT	POWER	
	gpm	lpm	psi	bar			hp	kW
237	2.3	8.7	1500	103	1725	16.5 mm	2.4	1.7
247	3.6	13.7	1200	83	1725	16.5 mm	3.0	2.2
277	4.2	16.0	1000	69	1725	16.5 mm	2.9	2.2
347	4.0	15.2	1800	124	1725	20 mm	4.9	3.6
357	5.0	19.0	1500	103	1725	20 mm	5.1	3.8



Model 277

## Direct-Drive Mounting Components

### BELL HOUSING ASSEMBLY, NEMA AND SAE

PUMP SERIES	MODELS	ELECTRIC MOTOR		HYDRAULIC MOTOR	
		MOTOR FRAME	BELL HOUSING ASSY	SAE TYPE*	BELL HOUSING ASSEMBLY
3CP Series	3CP1120 - 40, 3CP1231 - 41	56C - 145TC	76056.3CP	A2	76SAEA2.3CP
		182/184TC	76184.3CP	B2	76SAEB2.3CP
		213/215TC	76215.3CP	B4	76SAEB4.3CP
3FR Series	230 - 270, 231, 241, 271, 237, 247	56C - 145TC	76056.3FR	A2	76SAEA2.3FR
		182/184TC	76184.3FR	B2	76SAEB2.3FR
		213/215TC	76215.3FR	B4	76SAEB4.3FR
5CP Series	All 5CP Models rated at 1725 rpm	56C - 145TC	76056.5CP	A2	76SAEA2.5CP
		182/184TC	76184.5CP	B2	76SAEB2.5CP
		213/215TC	76215.5CP	B4	76SAEB4.5CP
		254/256TC	76256.5CP		
5FR Series	340, 350, 341, 351, 347, 357	182/184TC	76184.5FR	A2	76SAEA2.5FR
		213/215TC	76215.5FR	B2	76SAEB2.5FR
				B4	76SAEB4.5FR
7CP Series	7CP6110, 7CP6111	182/184TC	76184.7CP	A2	76SAEA2.7CP
		213/215TC	76215.7CP	B2	76SAEB2.7CP
		254/256TC	76256.7CP	B4	76SAEB4.7CP
7FR/8FR Series	56, 60, 700, 740, 781, 781K, 784	213/215TC	76215.7FR	A2	76SAEA2.7FR
		254/256TC	76256.7FR	B2	76SAEB2.7FR
				B4	76SAEB4.7FR

Bell housing assemblies include mounting hardware and flange

\*SAE Type: A2 = SAE "A" 2 Bolt, 3.25" Pilot, B2 = SAE "B" 2 Bolt, 4" Pilot, B4 = SAE "B" 4 Bolt, 4" Pilot



Bell Housing Series (Electric)



Bell Housing Assembly (Hydraulic)

### FLEXIBLE COUPLER ASSEMBLY, NEMA AND SAE

PUMP SERIES	MOTOR FRAME	FLEX COUPLER ASSY	HP RATING	SAE TYPE*	FLEX COUPLER ASSY	SHAFT TO SHAFT	HP RATING
3CP & 3FR	56C	8215	3	A2	8271	16.5 mm x 5/8"	10
	145TC	8210	3	B2	8272	16.5 mm x 7/8"	10
	182/184TC	8220	3	B4	8272	16.5 mm x 7/8"	10
	182/184TC	8225	10				
	213/215TC	8270	20				
5CP & 5FR	56C	8261	10	A2	8273	20 mm x 5/8"	10
	145TC	8260	10	B2	8274	20 mm x 7/8"	10
	182/184TC	8230	10	B4	8274	20 mm x 7/8"	10
	213/215TC	8275	20				
7CP & 7FR	254/256TC	8217	20				
	182/184TC	8370	10	A2	8371	24 mm x 5/8"	20
	213/215TC	8375	10	B2	8372	24 mm x 7/8"	20
	254/256TC	8380	20	B4	8372	24 mm x 7/8"	20

\*SAE Type: A2 = SAE "A" 2 Bolt, 3.25" Pilot, B2 = SAE "B" 2 Bolt, 4" Pilot, B4 = SAE "B" 4 Bolt, 4" Pilot



Flex Coupler Series

# Plunger Pumps

## SOLID SHAFT, BRASS MANIFOLD



Model 1810



Model 310

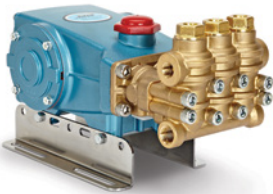

Model 700

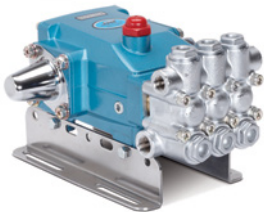

Model 5CP2120W

PUMP MODEL	MAXIMUM FLOW		MAXIMUM PRESSURE		RPM	SHAFT	POWER	
	gpm	lpm	psi	bar			hp	kW
5CP4110CSS	2.2	8.4	4000	276	1725	20 mm	6.0	4.4
3CP1130	2.4	9.1	2200	138	1725	16.5 mm	3.6	2.7
5CP3105CSS	2.5	9.5	3500	241	1725	20 mm	6.0	4.4
5CP4112CSS	2.7	10.3	4000	276	1725	20 mm	7.4	5.5
740	2.8	10.6	5000	345	1700	24 mm	9.6	7.2
1810**	3.0	11.4	10000	689	1500	30 mm	20.5	15.2
5CP4114CSS	3.2	12.1	4000	276	1725	20 mm	8.8	6.5
3CP1140	3.6	13.7	2200	152	1725	16.5 mm	5.4	4.0
5CP3110CSS	3.6	13.7	3500	241	1725	20 mm	8.6	6.4
5CP4116CSS	3.8	14.4	4000	276	1725	20 mm	10.4	7.8
310	4.0	15.2	2200	152	950	20 mm	6.0	4.5
5CP2120W	4.0	15.2	2500	172	950	20 mm	6.8	5.1
5CP2140WCS	4.0	15.2	2500	172	1725	20 mm	6.8	5.1
3CP1120	4.2	16.0	2200	152	1725	16.5 mm	6.3	4.7
5CP4118CSS	4.2	16.0	4000	276	1725	20 mm	11.5	8.6
5CP3160CSS	4.3	16.3	3500	241	1725	20 mm	10.3	7.6
5CP3120CSS	4.5	17.1	3500	241	1645	20 mm	10.8	8.0
5CP4120CSS	4.5	17.1	4000	276	1725	20 mm	12.3	9.1
60	4.7	17.9	4000	276	1725	24 mm	12.9	9.5
700	4.7	17.9	5000	345	1700	24 mm	16.1	12.0
5CP3120CSS	4.8	18.2	3000	207	1725	20 mm	9.9	7.3
310	5.0	19.0	1500	103	1190	20 mm	5.1	3.8
5CP2150W	5.0	19.0	2000	138	1725	20 mm	6.8	5.1
530	5.0	19.0	2500	172	1100	24 mm	8.6	6.3
5CP5120	5.0	19.0	3000	207	1415	20 mm	10.3	7.6
5CP5140CSS	5.5	20.9	3500	241	1500	20 mm	13.2	9.8
56	5.5	20.9	3500	241	1210	24 mm	13.2	9.8

\*\* 304 Stainless Manifold

### Selecting a Power Source

Positive displacement pumps can use a variety of different power sources, including electric motors, gas or diesel engines, hydraulic and pneumatic motors. Note: system power sources must be sized with adequate horsepower to handle the maximum system flow and pressure required.

#### Commonly Used Formulas

$$\text{Required Electric Brake HP}^* = \frac{\text{gpm} \times \text{psi}}{1460}$$

$$\text{Hydraulic Torque (ft. lbs.) Required} = 3.6 \times \frac{\text{gpm} \times \text{psi}}{\text{rpm}}$$

\*Standard 85% Overall Efficiency

# Plunger Pumps

## SOLID SHAFT, BRASS MANIFOLD

PUMP MODEL	MAXIMUM FLOW		MAXIMUM PRESSURE		RPM	SHAFT	POWER	
	gpm	lpm	psi	bar			hp	kW
5CP6120	6.0	22.8	1600	110	1450	20 mm	6.6	4.9
5CP5120	6.0	22.8	2500	172	1725	20 mm	10.3	7.6
1570	6.0	22.8	6000	414	1350	30 mm	24.7	18.2
5CP5140CSS	6.7	25.4	3000	207	1750	20 mm	13.8	10.3
650	7.0	26.6	3000	207	1000	30 mm	14.4	10.6
5CP6120	7.4	28.1	1200	83	1725	20 mm	6.1	4.5
5CP6190	8.0	30.4	1450	100	1450	20 mm	7.9	5.9
56	8.0	30.4	2500	172	1725	24 mm	13.7	10.1
1560	8.0	30.4	4000	276	1140	30 mm	21.9	16.2
5CP6190	10.0	38.0	1200	83	1800	20 mm	8.0	5.9
1050	10.0	38.0	2200	152	958	30 mm	15.1	11.2
660	10.0	38.0	3000	207	1429	30 mm	20.5	15.2
3550	10.0	38.0	6000	414	940	35 mm	41.1	30.7
6810**	10.0	38.0	10000	689	600	45 mm	68.5	50.7
7CP6110	10.5	39.9	2000	138	1725	24 mm	14.4	10.6
7CP6170	11.0	41.6	2000	138	1450	24 mm	15.1	11.2
1050	12.0	45.4	1800	124	1150	30 mm	14.8	11.0
7CP6170	12.0	45.4	1800	124	1600	24 mm	14.8	11.0
1580	12.0	45.4	3000	207	1180	30 mm	24.7	18.4
1530	15.6	59.3	1500	103	1450	30 mm	16.0	11.9
1540E	18.0	68.4	1200	83	1100	30 mm	14.8	11.0
2510	20.0	76.0	2000	138	1450	30 mm	27.4	20.3
3560	20.0	76.0	4000	276	1160	35 mm	54.8	40.5
2530	21.0	79.8	1200	83	860	30 mm	17.3	12.8
3520	23.0	87.4	2000	138	800	35 mm	31.5	23.3
2530	25.0	95.0	1000	69	1025	30 mm	17.1	12.7
3560	25.0	95.0	3000	207	1450	35 mm	51.4	38.0
3570*	30.0	113.6	3000	207	1080	35 mm	61.6	46.0
3535	36.0	136.2	1200	83	800	35 mm	29.6	21.9
6835	40.0	152.0	3000	207	625	45 mm	82.2	60.8
3545	45.0	171.0	1000	69	765	35 mm	30.8	22.8
3545HS*	50.0	190.0	1500	103	850	35 mm	51.4	38.0
6760	60.0	228.0	1200	83	520	45 mm	49.3	36.5
6775	75.0	285.0	1200	83	650	45 mm	61.6	45.6

\* Intermittent duty only – operating pump at stated flow and pressure for no more than 50% of time in any given hour.

\*\* 304 Stainless Manifold



Model 1570

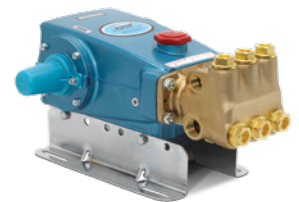

Model 660



Model 1540E



Model 3535

## Selecting a Drive

A variety of different drive options are offered by Cat Pumps. Most systems are belt-driven by a pulley or clutch, but there are also direct-drive options such as direct coupled, gearbox or hollow shaft direct drive.

### Commonly Used Formulas

$$\text{Desired rpm} = \text{Desired gpm} \times \frac{\text{Rated rpm}}{\text{Rated gpm}}$$

$$\text{Pump Pulley}^* \times \frac{\text{Pump rpm}}{\text{Motor/Engine rpm}} = \text{Motor Pulley}^*$$

\*Pitch Diameter

# Plunger Pumps

## SOLID SHAFT, 316 STAINLESS STEEL MANIFOLD



Model 311



Model 1051



Model 2531

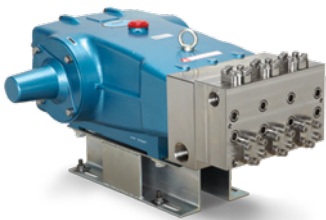

Model 6811

PUMP MODEL	MAXIMUM FLOW		MAXIMUM PRESSURE		RPM	SHAFT	POWER	
	gpm	lpm	psi	bar			hp	kW
3CP1231	2.3	8.7	2000	138	1725	16.5 mm	3.2	2.3
784	2.8	10.6	5000	345	1700	24 mm	9.6	7.2
3CP1241	3.6	13.7	2000	138	1725	16.5 mm	4.9	3.6
341	4.0	15.2	1800	124	1725	20 mm	4.9	3.6
5CPQ6241CS	4.0	15.2	2000	138	1725	20 mm	5.5	4.1
311	4.0	15.2	2200	152	950	20 mm	6.0	4.5
3CP1221	4.2	16.0	2000	138	1725	16.5 mm	5.8	4.3
781	4.5	17.1	5000	345	1700	24 mm	15.4	11.4
781	4.7	17.9	5000	345	1750	24 mm	16.1	12.0
351	5.0	19.0	1500	103	1725	20 mm	5.1	3.8
5CP6251	5.0	19.0	2000	138	1725	20 mm	6.8	5.1
5CPQ6221	6.0	22.8	2000	138	1400	20 mm	8.2	6.1
5CPQ6221	7.4	28.0	1200	83	1725	20 mm	6.1	4.5
1051	10.0	38.0	2200	152	958	30 mm	15.1	11.2
1861	10.0	38.0	3000	207	958	30 mm	15.1	11.2
3501	10.0	38.0	5000	345	915	35 mm	34.2	25.3
3801	10.0	38.0	5000	345	915	35 mm	34.2	25.3
7CP6111	10.5	39.9	2000	138	1725	24 mm	14.4	10.6
7CP6171	10.5	39.9	2000	138	1450	24 mm	14.4	10.6
1051	12.0	45.4	1800	124	1150	30 mm	14.8	11.0
3511	14.0	53.2	3000	207	800	35 mm	28.8	21.3
3811	14.0	53.2	3000	207	800	35 mm	28.8	21.3
6811	15.0	57.0	5000	345	600	45 mm	51.4	38.0
6801	15.0	57.0	7000	483	600	45 mm	71.9	53.2
1531	15.6	59.0	1500	103	1450	30 mm	16.0	11.9
1541	18.0	68.4	1200	83	1100	30 mm	14.8	11.0
2511	20.0	76.0	1500	103	1450	30 mm	20.5	15.2
2531	21.0	79.8	1200	83	860	30 mm	17.3	12.8
2831	21.0	79.8	1200	83	860	30 mm	17.3	12.8
3521	23.0	87.4	2000	138	800	35 mm	31.5	23.3
3821	23.0	87.4	2000	138	800	35 mm	31.5	23.3
2531	25.0	95.0	1000	69	1025	30 mm	17.1	12.7
6821	25.0	95.0	3000	207	615	45 mm	51.4	38.0
3531	36.0	136.2	1200	83	800	35 mm	29.6	21.9
3831	36.0	136.2	1200	83	800	35 mm	29.6	21.9
3531HS*	40.0	152.0	2000	138	888	35 mm	54.8	40.5
6831	40.0	152.0	2300	159	625	45 mm	63.0	46.6
3541	45.0	171.0	1000	69	765	35 mm	30.8	22.8
3841	45.0	171.0	1000	69	765	35 mm	30.8	22.8
6841	48.0	182.4	2000	138	615	45 mm	65.8	48.7
6761	60.0	228.0	1200	83	520	45 mm	49.3	36.5
6861	60.0	228.0	1200	83	520	45 mm	49.3	36.5
6771	75.0	285.0	1200	83	650	45 mm	61.6	45.6

\* Intermittent duty only – operating pump at stated flow and pressure for no more than 50% of time in any given hour.

# Plunger Pumps

## SOLID SHAFT, DUPLEX STAINLESS STEEL MANIFOLD

PUMP MODEL	MAXIMUM FLOW		MAXIMUM PRESSURE		RPM	SHAFT	POWER	
	gpm	lpm	psi	bar			hp	kW
1051D	10.0	38.0	2200	152	958	30 mm	15.1	11.2
661D	10.0	38.0	3000	207	1429	30 mm	20.5	15.2
1051D	12.0	45.4	1800	124	1150	30 mm	14.8	11.0
3822	23.0	87.4	2000	138	800	35 mm	31.5	23.3
3832	36.0	136.2	1200	83	800	35 mm	29.6	21.9
6762	60.0	228.0	1200	83	520	45 mm	49.3	36.5
6862	60.0	228.0	1200	83	520	45 mm	49.3	36.5
67102	80.0	302.8	1200	83	540	45 mm	65.8	49.1
67102	100.0	378.5	1000	69	680	45 mm	68.5	51.1
157R060	100.0	380.0	2700	186	310	100 mm	184.9	136.8
152R060	115.0	437.0	1200	83	360	100 mm	94.5	69.9
152R061	115.0	437.0	2000	138	360	100 mm	157.5	116.5
152R080	200.0	760.0	1200	83	355	100 mm	164.4	121.6
157R080	200.0	760.0	1560	108	355	100 mm	213.7	158.1
152R081	200.0	760.0	1560	108	355	100 mm	213.7	158.1
152R100	240.0	912.0	1000	69	270	100 mm	164.4	121.6



Model 6762



Model 152R100

## BELT DRIVE, SOLID SHAFT, NICKEL ALUMINUM BRONZE MANIFOLD

PUMP MODEL	MAXIMUM FLOW		MAXIMUM PRESSURE		RPM	SHAFT	POWER	
	gpm	lpm	psi	bar			hp	kW
237	2.3	8.7	1500	103	1725	16.5 mm	2.4	1.7
277	3.5	13.3	1500	103	1420	16.5 mm	3.6	2.7
247	3.6	13.7	1200	83	1725	16.5 mm	3.0	2.2
347	4.0	15.2	1800	124	1725	20 mm	4.9	3.6
317	4.0	15.2	2200	152	950	20 mm	6.0	4.5
277	4.2	16.0	1000	69	1725	16.5 mm	2.9	2.2
357	5.0	19.0	1500	103	1725	20 mm	5.1	3.8
1057	10.0	38.0	2200	152	958	30 mm	15.1	11.2
3507	10.0	38.0	5000	345	915	35 mm	34.2	25.3
1057	12.0	45.4	1800	124	1150	30 mm	14.8	11.0
3517	14.0	53.2	3000	207	800	35 mm	28.8	21.3
2537	21.0	79.8	1200	83	860	30 mm	17.3	12.8
3527	23.0	87.4	2000	138	800	35 mm	31.5	23.3
3537	36.0	136.2	1200	83	800	35 mm	29.6	21.9
3537HS*	40.0	152.0	2000	138	888	35 mm	54.8	40.5
6747	48.0	182.4	2000	138	615	45 mm	65.8	48.7
6767	60.0	228.0	1200	83	520	45 mm	49.3	36.5
6777	75.0	285.0	1200	83	650	45 mm	61.6	45.6

\* Intermittent duty only – operating pump at stated flow and pressure for no more than 50% of time in any given hour.



Model 277

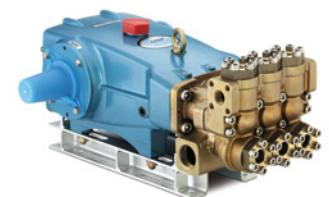

Model 3517

# Piston Pumps

## PISTON PUMPS, SOLID SHAFT, BRASS MANIFOLD

Belt Drive



Model 280

PUMP MODEL	MAXIMUM FLOW		MAXIMUM PRESSURE		RPM	SHAFT	POWER	
	gpm	lpm	psi	bar			hp	kW
280	3.0	11.4	1000	69	1330	16.5 mm	2.1	1.5
290	3.5	13.3	1200	83	1200	16.5 mm	2.9	2.1
333	4.0	15.2	1200	83	1070	16.5 mm	3.3	2.4
430	5.0	19.0	1000	69	1040	16.5 mm	3.4	2.5
323	5.0	19.0	1500	103	1000	20 mm	5.1	3.8
623	6.0	22.8	1200	83	850	25 mm	4.9	3.6
820	10.0	38.0	1000	69	940	25 mm	6.8	5.1
390	12.0	45.4	600	41	1200	20 mm	4.9	3.6
1010	13.0	49.4	700	48	900	25 mm	6.2	4.6
2520*	25.0	95.0	800	55	772	30 mm	13.7	10.1
6040	40.0	152.0	1500	103	500	45 mm	41.1	30.4
6020	60.0	228.0	1000	69	500	45 mm	41.1	30.4

\*Available as a model 2520C with flushed inlet manifold



Model 820

## PISTON PUMPS, SOLID SHAFT, 316 STAINLESS STEEL MANIFOLD

Belt Drive

PUMP MODEL	MAXIMUM FLOW		MAXIMUM PRESSURE		RPM	SHAFT	POWER	
	gpm	lpm	psi	bar			hp	kW
281	3.0	11.4	1000	69	1330	16.5 mm	2.1	1.5
291	3.5	13.3	1200	83	1200	16.5 mm	2.9	2.1
331	4.0	15.2	1200	83	1070	16.5 mm	3.3	2.4
431	5.0	19.0	1000	69	1040	16.5 mm	3.4	2.5
621	6.0	22.8	1200	83	850	25 mm	4.9	3.6
821	10.0	38.0	1000	69	940	25 mm	6.8	5.1
1011	13.0	49.4	700	48	900	25 mm	6.2	4.6
6041	40.0	152.0	1500	103	500	45 mm	41.1	30.4
6021	60.0	228.0	1000	69	500	45 mm	41.1	30.4



Model 2520

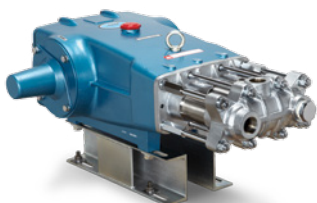

Model 6020

## TECH TIP

### Pump Rotation

Forward rotation (towards the manifold) is recommended to allow optimum lubrication of the crosshead area. If your installation does not allow for forward rotation, reverse rotation is acceptable if the crankcase oil is above the red dot in the oil gauge. This indicates adequate lubrication.



Forward Rotation



Reverse Rotation

# Flushed Manifold Pumps

## FLUSHED MANIFOLD PUMPS, SOLID SHAFT, BRASS

Belt Drive

PUMP MODEL	MAXIMUM FLOW		MAXIMUM PRESSURE		RPM	SHAFT	POWER	
	gpm	lpm	psi	bar			hp	kW
1810K**	3.0	11.4	10000	689	1500	30 mm	20.5	15.2
1540EC	18.0	68.4	1200	83	1100	30 mm	14.8	11.0
3520C	23.0	87.4	2000	138	800	35 mm	31.5	23.3
3535C	36.0	136.2	1200	83	800	35 mm	29.6	21.9

Model numbers ending in "C" indicate flushed cast manifold and "K" indicate flushed block manifold.

\*\*304 Stainless Steel Manifold

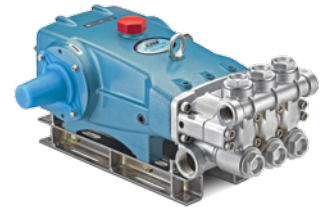

Model 3520C

## FLUSHED MANIFOLD PUMPS, SOLID SHAFT, 316 STAINLESS STEEL MANIFOLD

Belt Drive

PUMP MODEL	MAXIMUM FLOW		MAXIMUM PRESSURE		RPM	SHAFT	POWER	
	gpm	lpm	psi	bar			hp	kW
311C	4.0	15.2	2200	152	950	20 mm	6.0	4.5
781K	4.5	17.1	5000	345	1700	24 mm	15.4	11.4
1051C	10.0	38.0	2200	152	958	30 mm	15.1	11.2
661C	10.0	38.0	3000	207	1429	30 mm	20.5	15.2
1861K	10.0	38.0	3000	207	1429	30 mm	20.5	15.2
3501C	10.0	38.0	5000	345	915	35 mm	34.2	25.3
3801K	10.0	38.0	5000	345	915	35 mm	34.2	25.3
7CP6171C	10.5	39.9	2000	138	1450	24 mm	14.4	10.6
7CP6111C	10.5	39.9	2000	138	1750	24 mm	14.4	10.6
1051C	12.0	45.4	1800	124	1150	30 mm	14.8	11.0
3511C	14.0	53.2	3000	207	800	35 mm	28.8	21.3
3811K	14.0	53.2	3000	207	800	35 mm	28.8	21.3
6811K	15.0	57.0	5000	345	600	45 mm	51.4	38.0
6801K	15.0	57.0	7000	483	600	45 mm	71.9	53.2
1541C	18.0	68.0	1200	83	1100	30 mm	14.8	11.0
2831K	21.0	79.8	1200	83	860	30 mm	17.3	12.8
3521C	23.0	87.4	2000	138	800	35 mm	31.5	23.3
3821K	23.0	87.4	2000	138	800	35 mm	31.5	23.3
6821K	25.0	95.0	3000	207	615	45 mm	51.4	38.0
3531C	36.0	136.2	1200	83	800	35 mm	29.6	21.9
3831K	36.0	136.2	1200	83	800	35 mm	29.6	21.9
6831K	40.0	152.0	2300	159	625	45 mm	63.0	46.6
3541C	45.0	171.0	1000	69	765	35 mm	30.8	22.8
3841K	45.0	171.0	1000	69	765	35 mm	30.8	22.8
6841K	48.0	182.4	2000	138	615	45 mm	65.8	48.7
6861K	60.0	228.0	1200	83	520	45 mm	49.3	36.5

Model numbers ending in "C" indicate flushed cast manifold and "K" indicate flushed block manifold.



Model 781K

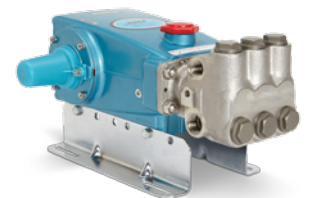

Model 1051C

## FLUSHED MANIFOLD PUMPS, SOLID SHAFT, DUPLEX STAINLESS STEEL MANIFOLD

Belt Drive

PUMP MODEL	MAXIMUM FLOW		MAXIMUM PRESSURE		RPM	SHAFT	POWER	
	gpm	lpm	psi	bar			hp	kW
67102C	100.0	378.5	1000	69	680	45 mm	68.5	51.1
152R060C	115.0	437.0	1200	83	360	100 mm	94.5	69.9
152R080C	200.0	760.0	1200	83	355	100 mm	164.4	121.6
152R100C	240.0	912.0	1000	69	270	100 mm	164.4	121.6

Model numbers ending in "C" indicate flushed cast manifold and "K" indicate flushed block manifold.

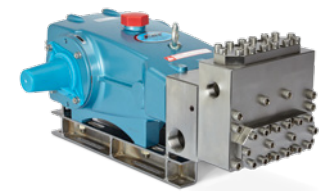

Model 3841K

# High Temperature Pumps



Model 1051.3400

## .3400 SERIES, HIGH-TEMPERATURE AND INTERMITTENT RUN DRY

The “.3400” Series pumps feature specially blended seals and V-packings, expanding pump operating performance to 200° F / 93° C. This modification also allows the pump to run intermittently dry without damaging the seals. Standard plunger pumps can be fitted with these specially blended seals. Ordering this configuration requires adding .3400 to pump base model. For example, a 310 pump fitted with high temperature seals will be 310.3400. Contact Cat Pumps for additional information.

# Triethylene Glycol (TEG) Pumps, 240° F



Model 3CP1120.44101

## HIGH-TEMPERATURE/TEG PUMPS, SOLID SHAFT, BRASS MANIFOLD

Belt and Bell Housing Drive

PUMP MODEL	MAXIMUM FLOW		MAXIMUM PRESSURE		RPM	SHAFT	POWER	
	gpm	lpm	psi	bar			hp	kW
3CP1130.44101	2.4	9.1	2200	152	1725	16.5 mm	3.6	2.7
5CP3105CS.44101	2.5	9.5	3500	241	1725	20 mm	6.0	4.4
3CP1140.44101	3.6	13.7	2200	152	1725	16.5 mm	5.4	4.0
5CP2120W.44101	4.0	15.2	2500	172	950	20 mm	6.8	5.1
5CP2140CS.44101	4.0	15.2	2500	172	1725	20 mm	6.8	5.1
3CP1120.44101	4.2	16.0	2200	152	1725	16.5 mm	6.3	4.7
5CP6120.44101	6.0	22.8	1600	110	1400	20 mm	6.6	4.9
1050.44101	10.0	38.0	2200	152	958	30 mm	15.1	11.2
1050.44101	12.0	45.4	1800	124	1150	30 mm	14.8	10.9
1530.44101	15.6	59.0	1500	103	1450	30 mm	16.0	11.9
1540E.44101	18.0	68.4	1200	83	1100	30 mm	14.8	10.9
2530.44101	21.0	79.8	1200	83	860	30 mm	17.3	12.8
2530.44101	25.0	95.0	1000	69	1025	30 mm	17.1	12.7
3535.44101	36.0	136.0	1200	83	800	35 mm	29.6	21.9

## HIGH-TEMPERATURE/TEG PUMPS, SOLID SHAFT, 316 STAINLESS STEEL AND NICKEL ALUMINUM BRONZE MANIFOLD

Belt and Bell Housing Drive



Model 1050.44101

PUMP MODEL	MAXIMUM FLOW		MAXIMUM PRESSURE		RPM	SHAFT	POWER	
	gpm	lpm	psi	bar			hp	kW
3CP1231.44101	2.3	8.7	2000	138	1725	16.5 mm	3.2	2.3
3CP1241.44101	3.6	13.7	2000	138	1725	16.5 mm	4.9	3.6
5CPQ6241CS.44101	4.0	15.2	2000	138	1725	20 mm	5.5	4.1
3CP1221.44101	4.2	16.0	2000	138	1725	16.5 mm	5.8	4.3
5CPQ6251.44101	5.0	19.0	2000	138	1725	20 mm	6.8	5.1
5CPQ6221.44101	6.0	22.8	2000	138	1400	20 mm	8.2	6.1
1051.44101	10.0	38.0	2200	152	958	30 mm	15.1	11.2
1051.44101	12.0	45.4	1800	124	1150	30 mm	14.8	10.9
3517.44101*	14.0	53.0	3000	207	800	35 mm	28.8	21.5
1531.44101	15.6	59.0	1500	103	1450	30 mm	16.0	11.9
1541.44101	18.0	68.4	1200	83	1100	30 mm	14.8	10.9
2531.44101	21.0	79.8	1200	83	860	30 mm	17.3	12.8
3521.44101	23.0	87.0	2000	138	800	35 mm	31.5	23.3
2531.44101	25.0	95.0	1000	69	1025	30 mm	17.1	12.7
3531.44101	36.0	136.2	1200	83	800	35 mm	29.6	21.9

\*Nickel Aluminum Bronze Manifold



# Washout Resistant Pumps

## B SERIES, SOLID SHAFT, SPECIAL BRASS MANIFOLD, VEHICLE WASH Belt and Bell Housing Drive

PUMP MODEL	MAXIMUM FLOW		MAXIMUM PRESSURE		RPM	SHAFT	POWER	
	gpm	lpm	psi	bar			hp	kW
340B	4.0	15.2	1800	124	1725	20 mm	4.9	3.7
310B, 310BQ*	4.0	15.2	2200	152	950	20 mm	6.0	4.5
5CP2120B	4.0	15.2	2500	172	950	20 mm	6.8	5.1
5CP2140BCS	4.0	15.2	2500	172	1725	20 mm	6.8	5.1
350B	5.0	19.0	1500	103	1725	20 mm	5.1	3.9
5CP2150B	5.0	19.0	2000	138	1725	20 mm	6.8	5.1

\*"Q" Option is designed for applications where a reduced sound level is desirable.



Model 310B

# Liquid CO<sub>2</sub> Pumps

Cat Pumps liquid CO<sub>2</sub> series of pumps feature modifications to accommodate the unique properties of liquid CO<sub>2</sub>. The seals are modified to handle low lubricity and low temperature that liquid CO<sub>2</sub> applications require. Pump manifolds are modified for inlet pressures to 800 psi (55 bar) and discharge pressures up to 5,000 psi (345 bar). Drive-end and manifold combinations are available to cover a wide flow range of flow from 0.68 to 30 gpm (2.6 to 113.6 lpm).

Cat Pumps offers full technical and engineering support to properly select pumps for the specific application. Pumps are available in brass and 316 stainless steel. Cat Pumps has provided liquid CO<sub>2</sub> pumping solutions for over 25 years, working closely with research facilities, universities, equipment manufacturers and site locations to design and provide the best solutions. Please contact Cat Pumps for additional information.

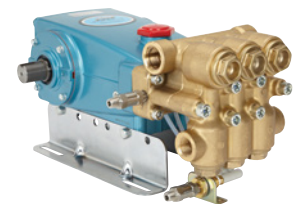

Model 1530RSCM.CO2

## Industry Leading Customer Service

Cat Pumps knowledgeable and experienced customer service team provides assistance with order information, as well as technical support in product selection, installation, maintenance, pump repair and general system troubleshooting.

Support is available M – F, 8:00 a.m. to 5:00 p.m. CST at (763) 780-5440.

Email: [techsupport@catpumps.com](mailto:techsupport@catpumps.com)

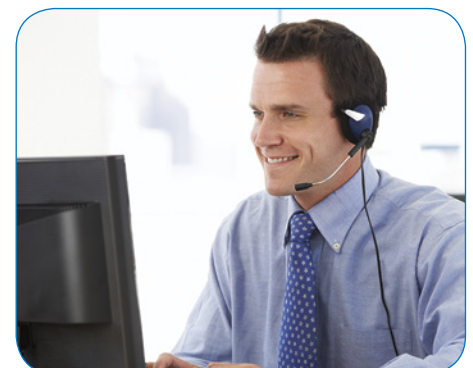

# ATEX Pumps

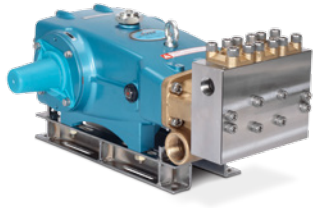

3560 ATEX

Under the ATEX Directive, equipment is designated by group, category, and zone. Cat Pumps has been certified as ATEX 2, which also covers ATEX 3 requirements.

ATEX certified high pressure pumps will be specially labeled and supplied with a signed ATEX Declaration of Conformity. Pumps will be numbered with the “.ATEX2” suffix added to the standard pump model number. Contact Cat Pumps for additional information.

The following pump series comply with the ATEX directive for Group 2, Category 2, and Zones 1 and 2. This Group 2 includes Zones G [1 & 2]

## Pump Series

- 3CP\* Plunger Pumps
- 3 Frame\* Plunger Pumps
- 5CP\* Plunger Pumps
- 5 Frame\* Plunger Pumps
- 7CP\* Plunger Pumps
- 7 Frame\* Plunger Pumps
- 8 Frame Plunger Pumps
- 15 Frame Plunger Pumps
- 18 Frame Plunger Pumps
- 25 Frame Plunger Pumps
- 28 Frame Plunger Pumps
- 35 Frame Plunger Pumps
- 38 Frame Plunger Pumps
- 60 Frame Plunger Pumps
- 68 Frame Plunger Pumps

\* Excludes models equipped with gearbox

# 1CX Series Compact Misting Pumps



## MODEL NUMBER SELECTION CHART

Pump with Electric Motor, 1000 psi max pressure

SERIES	FLOW (1750 RPM)	REGULATOR	ASSEMBLE OPTION	MOTOR OPTION*	PULSE HOSE OPTION
1CX	013 = .13 gpm	R = Regulator Included	D = Pump and motor shipped together – not assembled	1 = 8180	Blank = No Pulse Hose
	025 = .25 gpm			2 = 8182	
	050 = .5 gpm		A = Pump and motor assembled together	3 = 8185	P = Pulse Hose Included
		4 = 8183			
				5 = 8186	

**Example:** 1CX050RA2P = .5 gpm, Regulator, 8182 Motor, Assembled, Pulse Hose included

### \*Motor Options:

1. 8180 – 1/4 hp, ODP, 115/230 V, 60Hz, 1ph, 1750 rpm, 12 inch leads
2. 8182 – 1/2 hp, ODP, 115/230 V, 60Hz, 1ph, 1750 rpm, 12 inch leads
3. 8185 – 1/2 hp, ODP, 115/230 V, 60Hz, 1ph, 1750 rpm, terminal box
4. 8183 – 1/2 hp, ODP, 115/230 V, 50Hz, 1ph, 1450 rpm, terminal box
5. 8186 – 1/2 hp, TEFC, 115/230 V, 60 Hz, 1ph, 1750 rpm, terminal box

\* NOTE: Without pulse hose amp draw will increase as much as 2 amps depending upon pump model and discharge pressure.

\*\* HP Calculation (1CX Series only): GPM x PSI ÷ 1060

# 1XP Series Portable Extractor Pumps

## PORTABLE EXTRACTOR PUMPS, DIRECT DRIVE, ALUMINUM MANIFOLD Electric Motor (Induction) Included

PUMP MODEL	MAXIMUM FLOW		MAXIMUM PRESSURE		RPM	POWER	
	gpm	lpm	psi	bar		hp	kW
1XP050.031	0.5	1.9	800	54.4	1725	1/3	0.24
1XP075.031	0.75	2.9	600	40.8	1725	1/3	0.24
1XP085.031	0.85	3.2	600	40.8	1725	1/3	0.24
1XP100.031	1.0	3.8	500	34.5	1725	1/3	0.24
1XP125.031	1.25	4.8	400	27.2	1725	1/3	0.24
1XP150.031	1.5	5.7	325	22.1	1725	1/3	0.24
1XP200.031	2.0	7.6	250	17.0	1725	1/3	0.24
1XP050.051	0.4	1.5	1000	69.0	1725	1/2	0.37
1XP075.051	0.7	2.7	1000	69.0	1725	1/2	0.37
1XP085.051	0.8	3.0	1000	69.0	1725	1/2	0.37
1XP100.051	0.9	3.4	800	54.4	1725	1/2	0.37
1XP125.051	1.2	4.6	800	54.4	1725	1/2	0.37
1XP150.051	1.5	5.7	600	40.8	1725	1/2	0.37
1XP200.051	2.0	7.6	450	30.6	1725	1/2	0.37
1XP150.071	1.4	5.3	800	54.4	1725	3/4	0.55
1XP200.071	2.0	7.6	550	37.4	1725	3/4	0.55



Model 1XP150.031



Model 1XP150.03DC

## PORTABLE EXTRACTOR PUMPS, DIRECT DRIVE, ALUMINUM MANIFOLD Electric Motor (Permanent Magnet) Included

PUMP MODEL	MAXIMUM FLOW		MAXIMUM PRESSURE		RPM	POWER	
	gpm	lpm	psi	bar		hp	kW
1XP050.03DC	0.5	1.9	600	40.8	1725	1/3	0.24
1XP075.03DC	0.75	2.9	500	34.5	1725	1/3	0.24
1XP085.03DC	0.85	3.2	400	27.2	1725	1/3	0.24
1XP100.03DC	1.0	3.8	350	23.8	1725	1/3	0.24
1XP125.03DC	1.25	4.8	300	20.4	1725	1/3	0.24
1XP150.03DC	1.5	5.7	250	17.0	1725	1/3	0.24
1XP200.03DC	2.3	8.7	150	10.2	1725	1/3	0.24

## Unmatched Performance

The durability of the 1XP Series pumps makes it a great fit for portable extractors. Head-to-head testing against competitors shows once again: when it comes to long life and durability, nothing beats Cat Pumps. Get the facts - contact us for more information.

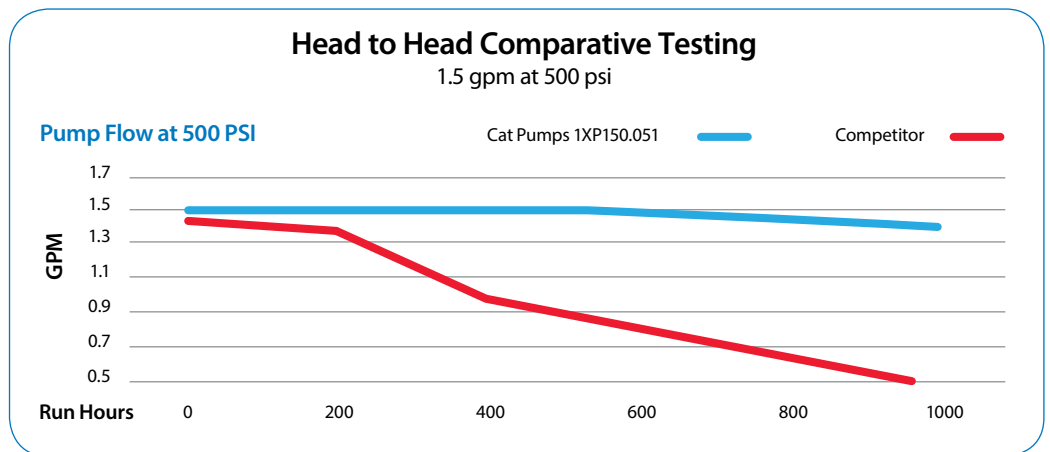

# Centrifugal Pumps

## 304 STAINLESS STEEL CASING

Centrifugal pumps offer solutions for high-flow, low-pressure industrial pumping needs. Typical fluids pumped include fresh water, semi-contaminated water or liquids with some suspended solids. Below is a sampling of popular centrifugal models that include the pump, seal and motor. Most of the pumps listed are rated at 3450 rpm, but many models are available at 1725 rpm. Contact Cat Pumps for more information.



### SUBMERSIBLE PUMPS WITH INTEGRAL MOTOR AND SEAL\*

PUMP MODEL	MAXIMUM FLOW		MAXIMUM PRESSURE			HORSEPOWER	
	gpm	lpm	psi	bar	ft/head	hp	kW
1K100**	45	170	10	0.69	23	0.3	0.2
1K201**	73	276	17	1.17	39	0.5	0.4
1K203**	73	276	17	1.17	39	0.5	0.4
1K301**	74	280	21	1.45	49	0.8	0.6
1K303**	74	280	21	1.45	49	0.8	0.6
2K102**	88	333	9	0.62	21	0.5	0.4
2K103**	88	333	9	0.62	21	0.5	0.4
2K200**	100	379	11	0.76	25	1.0	0.7
2K202**	100	379	11	0.76	25	1.0	0.7

\*Motor side seal is NBR fitted Carbon/Ceramic and impeller side seal is Viton® fitted Silicon Carbide/Silicone Carbide. Inquire about three phase options, \*\*Supplied with automatic float switch

### END-SUCTION MOTORIZED UNITS WITH TEFC 56J NEMA MOTOR

3K132WT3	38	144	62	4.3	143	2.0	1.5
3K392BT3	52	197	13	0.9	30	0.5	0.4
3K142WT3	63	238	32	2.2	74	1.0	0.7
3K152WT3	63	238	44	3.0	102	1.5	1.1
3K162WT3	63	238	63	4.3	146	3.0	2.2

Note: All motors are rated at 3450 rpm except model 3K392BT3 which is rated at 1725. Inquire about single phase options. All models listed are equipped with a Viton®/Carbon/Ceramic chemical resistant seal. Buna-N and high temperature seals are also available.

### END-SUCTION MOTORIZED UNITS WITH TEFC 213/215JM NEMA MOTOR

4K142WT3	153	579	90	6.2	208	0.5	0.4
4K192WT3	250	946	82	5.7	189	1.0	0.7
4K252WT3	380	1,438	84	5.8	194	1.0	0.7

Note: All motors are rated at 3450 rpm. Inquire about single phase options. All models listed are equipped with a Viton®/Carbon/Ceramic chemical resistant seal. Buna-N and high temperature seals are also available.

### SELF-PRIMING MOTORIZED UNITS WITH TEFC 56J NEMA MOTOR

5K112WT3	18.5	70	56	3.9	129	1.0	0.7
5K122WT3	18.5	70	82	5.7	189	2.0	1.5

Note: All motors are rated at 3450 rpm. Inquire about single phase options. All models listed are equipped with a Viton®/Carbon/Ceramic chemical resistant seal. Buna-N and high temperature seals are also available.

### MULTISTAGE MOTORIZED UNIT WITH NEMA MOTOR

PUMP MODEL	FLOW RANGE		FT/HEAD RANGE	HORSEPOWER RANGE
	gpm	lpm		
8K3 Series	3.2 to 23.8	12 to 90	30 to 760	0.5 to 5.0
8K5 Series	7 to 42	26 to 158	25 to 750	0.75 to 7.5
8K10 Series	8 to 80	30 to 302	40 to 850	1.5 to 15
8K18 Series	11 to 117	41 to 442	60 to 840	5 to 25
8K32 Series	66 to 185	249 to 700	50 to 925	5 to 40
8K45 Series	119 to 279	450 to 1056	40 to 775	7.5 to 50
8K64 Series	159 to 396	601 to 1498	50 to 512	10 to 50

# Demand Genuine Cat Pumps Accessories

MAXIMUM SYSTEM PERFORMANCE



Cat Pumps offers a wide range of high quality accessories adhering to the same exacting standards as our industry-leading pumps. Every accessory is performance tested and designed to match each pump's operating specifications. By demanding genuine Cat Pumps products, you receive the best value and lowest cost of ownership over the life of the system. Protect your pumping system investment with the brand you can trust — Cat Pumps.



Check out our complete line of accessories online at [catpumps.com](http://catpumps.com)

# Custom Pumping Systems

YOU DEFINE. WE DESIGN AND DELIVER.

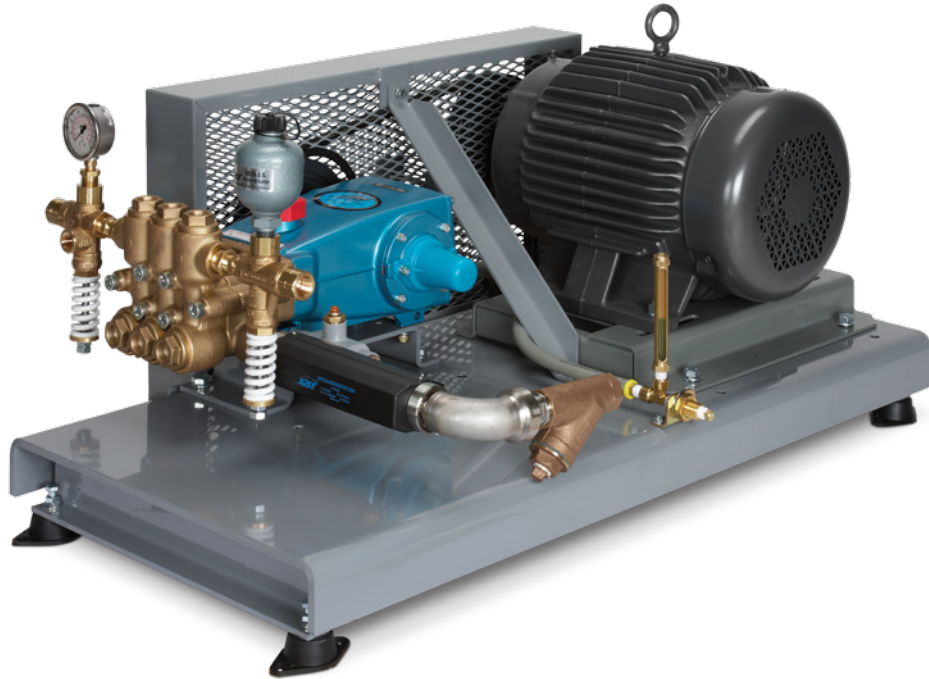

## Custom Engineered to Meet Your Application Demands



Cat Pumps is an industry leader in providing customers with quality custom-engineered pumping systems to meet a wide range of application needs. By selecting a Cat Pumps pumping system, customers eliminate the hassle and expense of designing, multiple source buying, fabricating and testing. Our knowledgeable and helpful technical sales team assists with proper component selection as well as installation, operation and maintenance support.

All systems are designed, built and pressure tested to verify performance. To begin the quoting process, contact us at (763) 780-5440 or submit the custom system quote form at [catpumps.com](http://catpumps.com).

With thousands of installations running around the world, Cat Pumps is the supplier of choice for custom pumping systems.

Call or go online to start your quote today.



# Custom Pumping Systems

## System Configuration

With extensive experience building thousands of systems, Cat Pumps can help determine the best configuration for any application.

### Base

System design starts with choosing the base that best fits the application. Numerous base configurations are available to meet space, portability, sound and material demands.

- Standard • Vertically Stacked • Portable • Enclosed • Multiple Pump

### Power Source

A qualified technical staff with extensive experience can assist in recommending the correct product for any power source available.

- Electric • Gas • Diesel • Hydraulic • Pneumatic

### Drive Package

A wide variety of drive packages are available to complement any power source of choice.

- Belt • Direct Drive • Gearbox • Flex Coupling/Bell Housing • Clutch

### Accessories

Choose from hundreds of high-quality genuine Cat Pumps accessories for optimum system performance and life.

- Regulator • Unloader • Relief / Pop-off Valve • Pressure Gauge
- Pulsation Dampener • Captive Acceleration Tube (C.A.T.)
- Inlet Filter / Strainer • Guns • Oil

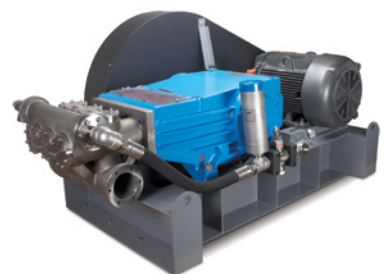

## Cat Pumps Advanced Control Options



Ask about the wide variety of advanced control options designed to provide maximum system performance as well as maximum system protection. Options include:

- Variable Frequency Drives (VFD)
- PID Loop (varies speed of pump to maintain system pressure)
- Multiple Pump Systems
- Low-Pressure Seal Monitors
- Auto Shutdowns (Temperature and Low Inlet Pressure)

Other control options are available upon request.

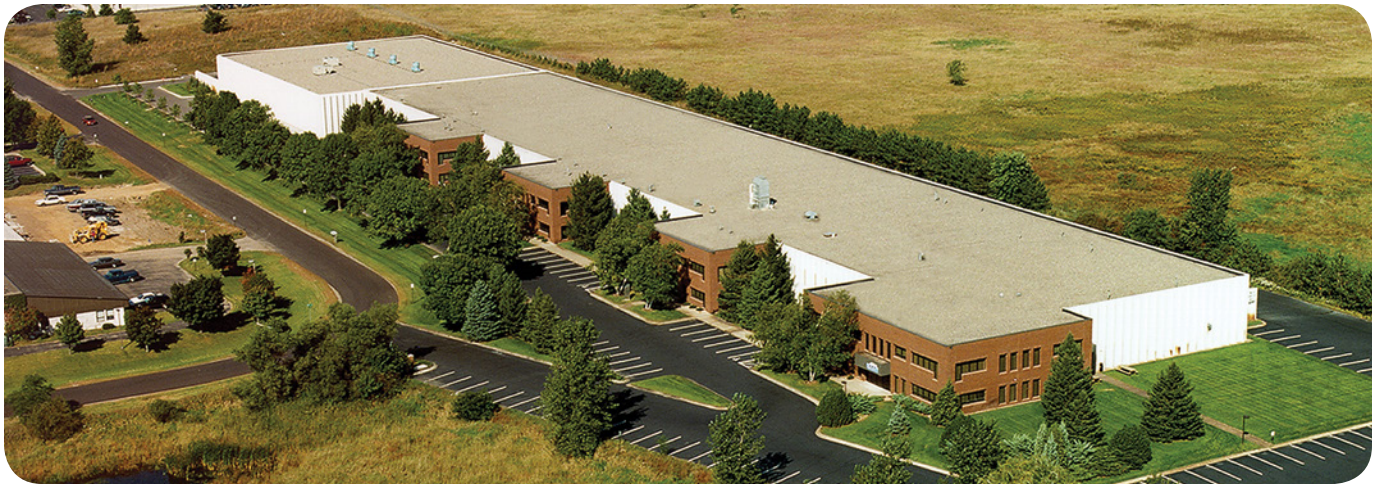

Cat Pumps occupies over 145,000 sq. ft. at its world headquarters in Minneapolis, MN.

## Cat Pumps Locations

### Cat Pumps – World Headquarters

1681 94th Lane Northeast  
Minneapolis, MN 55449  
USA

P: (763) 780-5440  
F: (763) 780-2958  
techsupport@catpumps.com  
www.catpumps.com

#### Territories Served

U.S., Canada

### International Division

P: (763) 780-5440  
F: (763) 785-4329  
intlsales@catpumps.com  
www.catpumps.com

#### Territories Served

Africa, Asia, Australia, Central and  
South America, Mexico, Middle East,  
New Zealand, Turkey

### Cat Pumps International N.V.

Heiveldekens 6A  
2550 Kontich  
Belgium

P: 32 3 450 71 50  
F: 32 3 450 71 51  
cpi@catpumps.be  
www.catpumps.be

#### Territories Served

Western Europe (except U.K.,  
Germany, and Austria)

### Cat Pump (U.K.) Ltd.

1 Fleet Business Park, Sandy Lane  
Church Crookham  
FLEET, Hampshire GU52 8BF  
England

P: +44 1252 622031  
F: +44 1252 626655  
sales@catpumps.co.uk  
technical@catpumps.co.uk  
www.catpumps.co.uk

#### Territories Served

England, Ireland, Scotland,  
N. Ireland, Wales

### Cat Pumps Deutschland GmbH

Buchwiesse 2, D-65510  
Idstein  
Germany

P: +49 6126 9303 0  
F: +49 6126 9303 33  
catpumps@t-online.de  
www.catpumps.de

#### Territories Served

Austria, Commonwealth of Independent States  
(CIS), Germany and Eastern Europe

**SALES, DISTRIBUTION, SERVICE** Call today for product and application assistance. (763) 780-5440 or visit us at [www.catpumps.com](http://www.catpumps.com)



### CAT PUMPS

1681 - 94TH LANE N.E. MINNEAPOLIS, MN 55449-4324  
PHONE (763) 780-5440 — FAX (763) 780-2958  
e-mail: techsupport@catpumps.com  
www.catpumps.com

For International inquiries go to [www.catpumps.com](http://www.catpumps.com) and navigate to the "Contact Us" link.

©2016 Cat Pumps Inc. All rights reserved. All written and visual data contained in this document are based on the latest product information available at the time of publication. Cat Pumps reserves the right to make changes at any time without notice. All other brand names or marks are used for identification purposes and are trademarks of their respective owners.