



# Industrial Valves

Ball Valves

Needle Valves







































Ground Plug Shutoff  
Valves/Drain Cocks





<b>Female Ports</b>	<b>V500P</b> Female-Female	<b>V502P</b> Panel Mount	<b>V520P</b> Economy Series	<b>V533P</b> 3 Way Diversion	<b>V540P</b> 4 Way	<b>V600P</b> 6 Port Diversion
	 p. K8	 p. K13	 p. K19	 p. K21	 p. K21	 p. K26
<b>V633P</b> 6 Port Diversion	<b>V500CS</b> Carbon Steel	<b>V502CS</b> Panel Mount Carbon Steel	<b>V502SS</b> Panel Mount Stainless	<b>MV709</b> Micro Valve	<b>MV200</b> Mini Valve	<b>MV609</b> Mini Valve
 p. K26	 p. K28	 p. K28	 p. K36	 p. K37	 p. K39	 p. K39
<b>4203</b> Axial Valve-NPT	<b>4202</b> Axial Valve-BSP	<b>PV609</b> Plug Valve	<b>Male-Female Ports</b>	<b>V501P</b> Male-Female	<b>V590P</b> 90° Valve	<b>V590P-X-04</b> 90° Valve
 p. K60	 p. K60	 p. K46		 p. K11	 p. K23	 p. K23
<b>V501SS</b> Stainless Steel	<b>MV708</b> Micro Valve	<b>MV608</b> Mini Valve	<b>PV608</b> Plug Valve	<b>Solder Ports</b>	<b>V509P</b> Solder - Solder	
 p. K34	 p. K37	 p. K39	 p. K46		 p. K16	
<b>Male-Male Ports</b>	<b>V591P</b> 90° Valve	<b>V591P-X-04</b> 90° Valve	<b>PV607</b> Plug Valve	<b>Straight Thread Ports</b>	<b>V506P</b> Female - Female	<b>V510P</b> Male - Female
	 p. K23	 p. K23	 p. K46		 p. K15	 p. K18
<b>V506CS</b> Carbon Steel	<b>Straight Thread Ports-High Pressure</b>	<b>V506HP</b> Straight Thread	<b>Female Ports-High Pressure</b>	<b>V500HP</b> Female Ports	<b>Female Ports-Padlocking-High Pressure</b>	<b>VP500HP</b> Female Ports-Padlocking
 p. K30		 p. K33		 p. K32		 p. K32
<b>Barb to Female Port</b>	<b>V500HB</b> Barb to Female Port	<b>Padlocking</b>	<b>VP500P</b> Female Ports	<b>VP501P</b> Male - Female	<b>VP502P</b> Panel Mount	<b>VP510P</b> Straight Thread
	 p. K24		 p. K8	 p. K11	 p. K13	 p. K18
<b>VP500CS</b> Carbon Steel	<b>VP502CS</b> Panel Mount	<b>VP502SS</b> Stainless Steel	<b>Straight Thread Ports-Padlocking-High Pressure</b>	<b>VP506HP</b> Straight Thread		
 p. K28	 p. K28	 p. K36		 p. K33		

<b>Vented</b>	<b>VV500P</b> Female Ports  p. K8	<b>VV501P</b> Male-Female  p. K11	<b>VV502P</b> Panel Mount  p. K13	<b>Vented-Padlocking</b>	<b>VVP500P</b> Female Ports  p. K8	<b>VVP501P</b> Male-Female  p. K11		
	<b>VVP502P</b> Panel Mount  p. K13	<b>Polypropylene Ball Valves</b>			<b>VME</b> Male Elbow  p. K41	<b>VFE</b> Female Elbow  p. K41	<b>VUC</b> Union Connector  p. K41	<b>VEU</b> Elbow Union  p. K41
<b>VFC</b> Female Connector  p. K41	<b>VUCPB</b> Union Connector  p. K42	<b>VAS</b> Angle Stop  p. K42	<b>VME</b> Male Elbow  p. K42	<b>VFE</b> Female Elbow  p. K42	<b>VUC</b> Union Connector  p. K42	<b>VEU</b> Elbow Union  p. K42		
<b>VMC</b> Male Connector  p. K43	<b>VFC</b> Female Connector  p. K43	<b>VTEU</b> Tube Elbow Union  p. K43	<b>VFC</b> Barbed Female Connector  p. K43	<b>VFE</b> Barbed Female Elbow  p. K43	<b>VMC</b> Barbed Male Connector  p. K43	<b>VME</b> Barbed Male Elbow  p. K44		
<b>VUC</b> Barbed Union Connector  p. K44	<b>VUCPB</b> Union Connector Barbed x Tube  p. K44	<b>BVC</b> Ball Valve Clip  p. K44	<b>Tee Handle</b>	<b>V500P-X-04</b> Female Ports  p. K9	<b>V501P-X-04</b> Male - Female  p. K11	<b>V502P-X-04</b> Panel Mount  p. K13		
<b>V510P-X-04</b> Straight Thread  p. K18	<b>V500CS-X-04</b> Carbon Steel  p. K28	<b>Oval Handle</b>		<b>V500P-X-21</b> Female Ports  p. K9	<b>V501P-X-21</b> Male - Female  p. K11	<b>V502P-X-21</b> Panel Mount  p. K13	<b>V510P-X-21</b> Straight Thread  p. K18	
<b>V500CS-X-21</b> Carbon Steel  p. K29	<b>V502CS-X-21</b> Panel Mount - Carbon Steel  p. K29		<b>V502SS-X-21</b> Oval Handle  p. K36	<b>Short Handle</b>	<b>V502SS-X-20</b> Panel Mount  p. K36			
<b>Metric Female Ports</b>	<b>BVGC</b> Female Ports  p. K51	<b>BVGTG</b> Female Ports  p. K51	<b>BVGL</b> Female Ports Long  p. K53		<b>BVGTG</b> Female Ports Long  p. K53	<b>MBVG</b> Compact  p. K57		

<b>Metric Padlocking</b>	<b>BVG4PLOCK</b> Female Ports	<b>Needle Valves</b>	<b>NV101F</b> Female - Male	<b>NV102F</b> Flare	<b>NV103F</b> Flare - Male Pipe	<b>NV104C- NV104CA</b> Compression - Pipe
	 p. K55		 p. K65	 p. K65	 p. K65	 p. K65
<b>NV105C- NV105CA</b> Compression	<b>NV106C- NV106CA</b> Compression - Pipe	<b>NV107P</b> Pipe	<b>NV108P</b> Female - Male	<b>NV109P</b> Female	<b>NV311P</b> Poly-Tite	<b>NV312P</b> Poly-Tite
 p. K65	 p. K66	 p. K66	 p. K66	 p. K66	 p. K66	 p. K66
<b>Shutoff Valves</b>	<b>V203F</b> Flare	<b>V204F</b> Flare - Pipe	<b>V303C-V303CA</b> Compression	<b>V304C-V304CA</b> Compression - Pipe	<b>V401P</b> Pipe	<b>V402P</b> Female - Pipe
	 p. K68	 p. K68	 p. K68	 p. K68	 p. K68	 p. K68
<b>V403P</b> Female	<b>V406P</b> 3 Way	<b>V407P</b> 4 Way	<b>DC601</b> Pipe	<b>Drain Cocks</b>	<b>DCR601</b> Internal Seal	<b>DC602</b> Internal Seal
 p. K68	 p. K68	 p. K68	 p. K68		 p. K69	 p. K69
<b>DC603</b> Internal Seal	<b>DC604</b> External Seal	<b>DC606</b> External Seal	<b>DC607</b> Bib Drain	<b>Auxiliary</b>	<b>V502P-X-ACT</b> Actuator	<b>V502SS-X-ACT</b> Actuator
 p. K69	 p. K69	 p. K69	 p. K69		 p. K48	 p. K48
<b>V502P-X-SUB</b> Sub-Assembly	<b>V502SS-X-SUB</b> Sub-Assembly	<b>ACT-P-X-KIT</b> Brass Actuator kit	<b>ACT-SS-X-KIT</b> Stainless Actuator Kit	<b>STX-P</b> Stem Extension	<b>PVMB-001</b> Mounting Bracket	<b>HV104C-KIT</b> Humidifier Valve Kit
 p. K49	 p. K49	 p. K49	 p. K49	 p. K63	 p. K46	 p. K65
<b>SPV104C-KIT</b> Self Piercing Kit	<b>HV104C</b> Humidifier Valve					
 p. K65	 p. K65					

# Ball Valves

## Brass Series 500



Parker's industrial ball valves are intended for general purpose use. Ball valves are intended for use in the fully open or closed positions. Throttling of the valve may result in premature seal failure and/or inability to turn the valve handle.

### Product Features:

- Forged brass body
- Chrome plated brass ball
- PTFE seats/seals
- Steel handle

### Style:

- V-Valve
- VP-Valve, padlocking handle
- VV-Valve, vented
- VVP-Valve, vented, padlocking handle

### Type:

- 500-Female/Female PTF ports

### Material:

- P-Brass
- PN-Nickel plated

### Options:

- 01-Stainless Steel Ball & Stem
- 02-Stainless Steel Handle & Nut
- 03-Stainless Steel Ball, Stem, Handle & Nut
- 04-Tee Handle
- 08-Unmarked yellow vinyl handle cover
- 21-Oval Handle

### Specifications:

#### Pressure Range:

- 600 WOG , Cold Non-shock
- Saturated Steam up to 150 psi
- Vacuum Service to 29 Inches Hg
- Vented up to 250 psi

#### Temperature Range

- 0° to +350°F

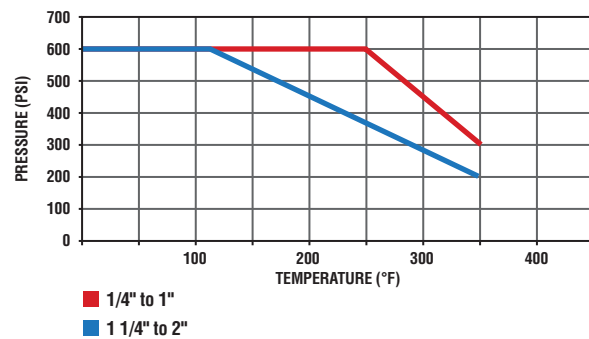

FLOW DATA	
VALVE SIZE	CV
1/4	4.0
3/8	5.8
1/2	12.0
3/4	25.0
1	35.0
1-1/4*	57.0
1-1/2*	92.0
2*	224.0

\*For these part numbers only the \* options are available.



### Female-Female Pipe Ends V500P

PART NO.	PIPE THREAD [PTF]	B HEX	C HEX	H	L	M	N	FLOW DIA. D
V500P-4	1/4	15/16	15/16	3.96	4.90	2.03	2.47	.375
V500P-6	3/8	15/16	15/16	3.96	4.90	2.03	2.47	.375
V500P-8	1/2*	1-1/16	1-1/16	3.96	5.00	2.20	2.58	.500
V500P-12	3/4**	1-1/4	1-5/16	3.96	5.25	2.42	2.81	.685
V500P-16	1**	1-1/2	1-9/16	3.96	5.34	2.75	3.08	.875

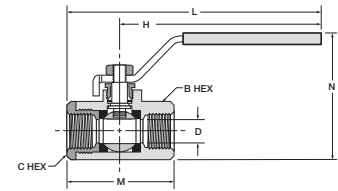

### Female-Female Pipe Ends V500P-20, V500P-24, V500P-32

PART NO.	PIPE THREAD [NPT]	OCTAGON	H	L	M	N	FLOW DIA. D
V500P-20	1-1/4	1.93	6.22	8.05	3.66	3.01	1.18
V500P-24	1-1/2	2.13	6.22	8.23	4.02	3.25	1.50
V500P-32	2	2.69	6.22	8.58	4.76	3.52	1.89

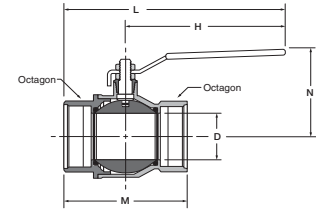

### Vented, Female Pipe Ends VV500P

PART NO.	PIPE THREAD [PTF]	B HEX	C HEX	K	H	L	M	N	D FLOW Ø
VV500P-4	1/4	15/16	15/16	1.11	3.96	4.90	2.03	2.47	.375
VV500P-6	3/8	15/16	15/16	1.11	3.96	4.90	2.03	2.47	.375
VV500P-8	1/2*	1-1/16	1-1/16	1.23	3.96	5.00	2.20	2.58	.500
VV500P-12	3/4**	1-1/4	1-5/16	1.45	3.96	5.25	2.42	2.81	.685
VV500P-16	1**	1-1/2	1-9/16	1.58	3.96	5.34	2.75	3.08	.875

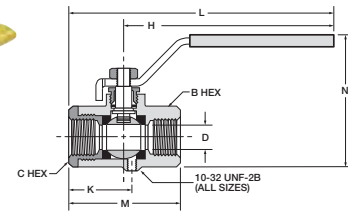

### Locking Handle, Female Pipe Ends VP500P

PART NO.	PIPE THREAD [PTF]	B HEX	C HEX	H	L	M	N	D FLOW Ø
VP500P-4	1/4	15/16	15/16	3.96	4.90	2.03	2.47	.375
VP500P-6	3/8	15/16	15/16	3.96	4.90	2.03	2.47	.375
VP500P-8	1/2*	1-1/16	1-1/16	3.96	5.00	2.20	2.58	.500
VP500P-12	3/4**	1-1/4	1-5/16	3.96	5.25	2.42	2.81	.685
VP500P-16	1**	1-1/2	1-9/16	3.96	5.34	2.75	3.08	.875
FOR USE WITH 5/16" Ø SHANK LOCK; .330								
VP500P-20	1-1/4	1-15/16	1-15/16	6.22	8.05	3.66	4.04	1.180
VP500P-24	1-1/2	2-1/8	2-1/8	6.22	8.23	4.02	4.52	1.500
VP500P-32	2	2-11/16	2-11/16	6.22	8.60	4.76	5.07	1.890
FOR USE WITH 9/32" Ø SHANK LOCK; .310								

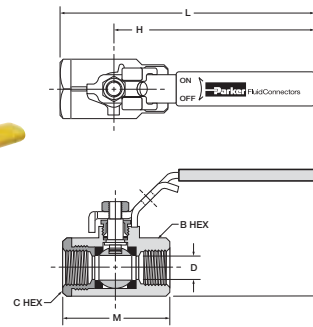

### OSHA 29 CFR Part 1910 Vented, Locking Handle, Female Pipe Ends VVP500P

PART NO.	PIPE THD [PTF]	B HEX	C HEX	K	H	L	M	N	D FLOW Ø
VVP500P-4	1/4	15/16	15/16	1.11	3.96	4.90	2.03	2.47	.375
VVP500P-6	3/8	15/16	15/16	1.11	3.96	4.90	2.03	2.47	.375
VVP500P-8	1/2*	1-1/16	1-1/16	1.23	3.96	5.00	2.20	2.58	.500
VVP500P-12	3/4**	1-1/4	1-5/16	1.45	3.96	5.25	2.42	2.81	.685
VVP500P-16	1**	1-1/2	1-9/16	1.58	3.96	5.34	2.75	3.08	.875
FOR USE WITH 5/16" Ø SHANK LOCK									

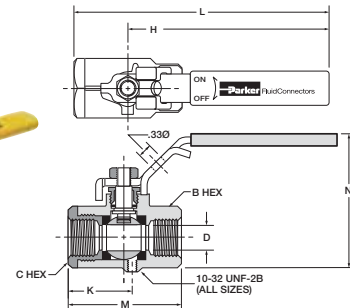

\*PTF Special Short. \*\*PTF SPL Extra Short

### Tee Handle, Female Pipe Ends V500P-X-04

PART NO.	PIPE THREAD (PTF)	B HEX	C HEX	H	L	M	N	D FLOW Ø
V500P-4-04	1/4	15/16	15/16	1.25	2.50	2.03	1.87	.375
V500P-6-04	3/8	15/16	15/16	1.25	2.50	2.03	1.87	.375
V500P-8-04	1/2*	1-1/16	1-1/16	1.25	2.50	2.20	1.98	.500
V500P-12-04	3/4**	1-1/4	1-5/16	1.25	2.50	2.42	2.20	.685
V500P-16-04	1**	1-1/2	1-9/16	1.25	2.50	2.75	2.48	.875

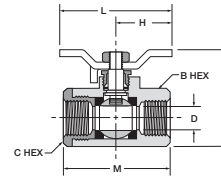

### Oval Handle, Female Pipe Ends V500P-X-21

PART NO.	PIPE THREAD (PTF)	B HEX	C HEX	H	L	M	N	D FLOW Ø
V500P-4-21	1/4	15/16	15/16	1.74	3.49	2.03	2.38	.375
V500P-6-21	3/8	15/16	15/16	1.74	3.49	2.03	2.38	.375
V500P-8-21	1/2*	1-1/16	1-1/16	1.74	3.49	2.20	2.49	.500
V500P-12-21	3/4**	1-1/4	1-5/16	1.74	3.48	2.42	2.71	.685
V500P-16-21	1**	1-1/2	1-9/16	1.74	3.48	2.75	2.99	.875

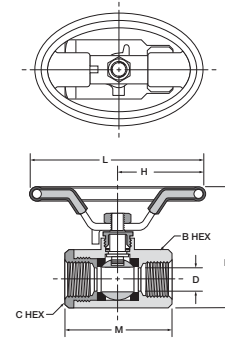

\*PTF Special Short. \*\*PTF SPL Extra Short



# Ball Valves Brass Series 501



## Product Features:

- Forged brass body
- Chrome plated brass ball
- PTFE seats/seals
- Steel handle

## Style:

- V-Valve
- VP-Valve, padlocking handle
- VV-Valve, vented
- VVP-Valve, vented, padlocking handle

## Type:

- 501-Male/Female PTF ports

## Material:

- P-Brass
- PN-Nickel plated

## Options:

- 01-Stainless Steel Ball & Stem
- 02-Stainless Steel Handle & Nut
- 03-Stainless Steel Ball, Stem, Handle & Nut
- 04-Tee Handle
- 08-Unmarked yellow vinyl handle cover
- 21-Oval Handle

## Specifications:

### Pressure Range:

- 600 WOG , Cold Non-shock
- Saturated Steam up to 150 psi
- Vacuum Service to 29 Inches Hg
- Vented up to 250 psi

### Temperature Range

- 0° to +350°F

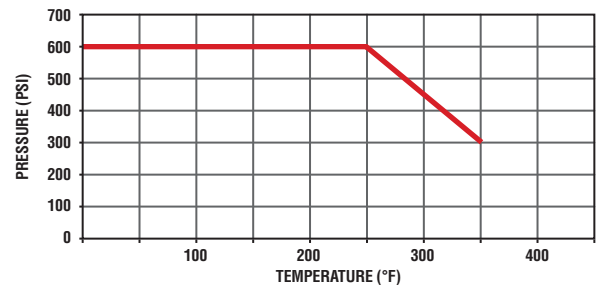

FLOW DATA	
VALVE SIZE	CV
1/4	6.3
3/8	5.7
1/2	10.0
3/4	25.0
1	35.0

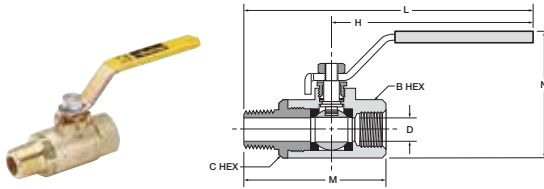

**Male-Female Pipe Ends V501P**

PART NO.	FEMALE PIPE THRD [PTF]	MALE PIPE THRD [NPTF]	B HEX	C HEX	H	L	M	N	D FLOW Ø
V501P-4	1/4	1/4	15/16	15/16	3.96	5.46	2.59	2.47	.344
V501P-6	3/8	3/8	15/16	15/16	3.96	5.46	2.59	2.47	.375
V501P-8	1/2*	1/2	1-1/16	1-1/16	3.96	5.75	2.94	2.58	.500
V501P-12	3/4**	3/4*	1-1/4	1-5/16	3.96	5.83	3.00	2.81	.685
V501P-16	1**	1*	1-1/2	1-9/16	3.96	6.19	3.60	3.08	.875

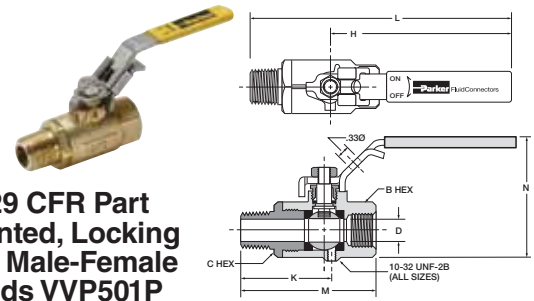

**OSHA 29 CFR Part 1910 Vented, Locking Handle, Male-Female Pipe Ends VVP501P**

PART NO.	FEMALE PIPE THRD [PTF]	MALE PIPE THRD [NPTF]	B HEX	C HEX	K	H	L	M	N	D FLOW Ø
VVP501P-4	1/4	1/4	15/16	15/16	1.67	3.96	5.46	2.59	2.47	.344
VVP501P-6	3/8	3/8	15/16	15/16	1.67	3.96	5.46	2.59	2.47	.375
VVP501P-8	1/2*	1/2	1-1/16	1-1/16	1.98	3.96	5.75	2.95	2.58	.500
VVP501P-12	3/4**	3/4	1-1/4	1-5/16	2.03	3.96	5.83	3.00	2.81	.685
VVP501P-16	1**	1	1-1/2	1-9/16	2.43	3.96	6.19	3.60	3.08	.875

For use with 5/16" Ø shank lock

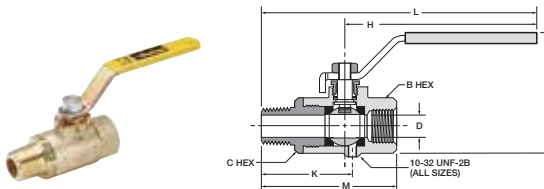

**Vented, Male-Female Pipe Ends VV501P**

PART NO.	FEMALE PIPE THRD [PTF]	MALE PIPE THRD [NPTF]	B HEX	C HEX	K	H	L	M	N	D FLOW Ø
VV501P-4	1/4	1/4	15/16	15/16	1.67	3.96	5.46	2.59	2.47	.344
VV501P-6	3/8	3/8	15/16	15/16	1.67	3.96	5.46	2.59	2.47	.375
VV501P-8	1/2*	1/2	1-1/16	1-1/16	1.98	3.96	5.75	2.95	2.58	.500
VV501P-12	3/4**	3/4*	1-1/4	1-5/16	2.03	3.96	5.83	3.00	2.81	.685
VV501P-16	1**	1*	1-1/2	1-9/16	2.43	3.96	6.19	3.60	3.08	.875

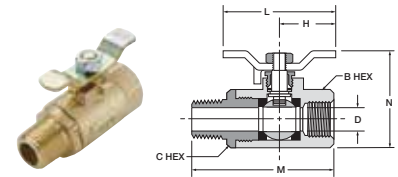

**Tee Handle, Male-Female Pipe Ends V501P-X-04**

PART NO.	FEMALE PIPE THRD [PTF]	MALE PIPE THRD [NPTF]	B HEX	C HEX	H	L	M	N	D FLOW Ø
V501P-4-04	1/4	1/4	15/16	15/16	1.25	2.50	2.59	1.87	.344
V501P-6-04	3/8	3/8	15/16	15/16	1.25	2.50	2.59	1.87	.375
V501P-8-04	1/2*	1/2	1-1/16	1-1/16	1.25	2.50	2.95	1.98	.500
V501P-12-04	3/4**	3/4	1-1/4	1-5/16	1.25	2.50	3.00	2.20	.685
V501P-16-04	1**	1	1-1/2	1-9/16	1.25	2.50	3.60	2.48	.875

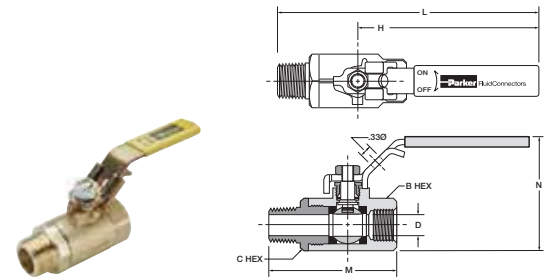

**Locking Handle, Male-Female Pipe Ends VP501P**

PART NO.	FEMALE PIPE THRD [PTF]	MALE PIPE THRD [NPTF]	B HEX	C HEX	H	L	M	N	D FLOW Ø
VP501P-4	1/4	1/4	15/16	15/16	3.96	5.46	2.59	2.47	.344
VP501P-6	3/8	3/8	15/16	15/16	3.96	5.46	2.59	2.47	.375
VP501P-8	1/2*	1/2	1-1/16	1-1/16	3.96	5.75	2.95	2.58	.500
VP501P-12	3/4**	3/4*	1-1/4	1-5/16	3.96	5.83	3.00	2.81	.685
VP501P-16	1**	1*	1-1/2	1-9/16	3.96	6.19	3.60	3.08	.875

For use with 5/16" Ø shank lock

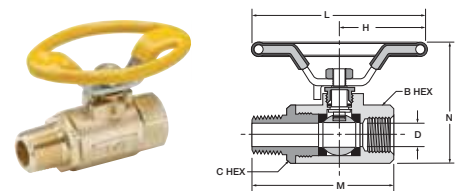

**Oval Handle, Male-Female Pipe Ends V501P-X-21**

PART NO.	FEMALE PIPE THRD [PTF]	MALE PIPE THRD [NPTF]	B HEX	C HEX	H	L	M	N	D FLOW Ø
V501P-4-21	1/4	1/4	15/16	15/16	1.74	3.49	2.59	2.38	.344
V501P-6-21	3/8	3/8	15/16	15/16	1.74	3.49	2.59	2.38	.375
V501P-8-21	1/2*	1/2	1-1/16	1-1/16	1.74	3.49	2.95	2.49	.500
V501P-12-21	3/4**	3/4	1-1/4	1-5/16	1.74	3.48	3.00	2.71	.685
V501P-16-21	1**	1	1-1/2	1-9/16	1.74	3.48	3.60	2.99	.875

\*PTF Special Short. \*\*PTF SPL Extra Short



# Ball Valves Brass Series 502



## Product Features:

- Forged brass body
- Chrome plated brass ball
- PTFE seats/seals
- Steel handle

## Style:

- V-Valve
- VP-Valve, padlocking handle
- VV-Valve, vented
- VVP-Valve, vented, padlocking handle

## Type:

- 502-Female/Female PTF ports

## Material:

- P-Brass
- PN-Nickel plated

## Options:

- 01-Stainless Steel Ball & Stem
- 02-Stainless Steel Handle & Nut
- 03-Stainless Steel Ball, Stem, Handle & Nut
- 04-Tee Handle
- 08-Unmarked yellow vinyl handle cover
- 21-Oval Handle

## Specifications:

### Pressure Range:

- 600 WOG , Cold Non-shock
- Saturated Steam up to 150 psi
- Vacuum Service to 29 Inches Hg
- Vented up to 250 psi

### Temperature Range

- 0° to +350°F

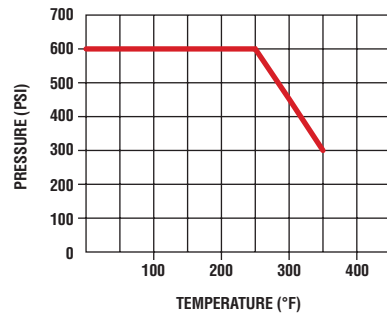

FLOW DATA	
VALVE SIZE	CV
1/4	4.0
3/8	5.8
1/2	12.0
3/4	25.0
1	35.0

## Mounting detail for all sizes

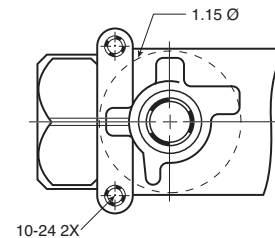

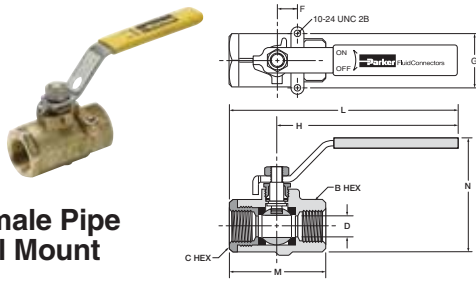

**Female-Female Pipe Ends, Panel Mount V502P**

PART NO.	PIPE THD. [PTF]	B HEX	C HEX	F	G	H	L	M	N	FLOW DIA. D
V502P-4	1/4	15/16	15/16	.50	1.12	3.96	4.90	2.03	2.47	.375
V502P-6	3/8	15/16	15/16	.50	1.12	3.96	4.90	2.03	2.47	.375
V502P-8	1/2*	1-1/16	1-1/16	.50	1.12	3.96	5.00	2.20	2.58	.500
V502P-12	3/4**	1-1/4	1-5/16	.87	1.37	3.96	5.25	2.42	2.81	.685
V502P-16	1**	1-1/2	1-9/16	.87	1.37	3.96	5.34	2.75	3.08	.875

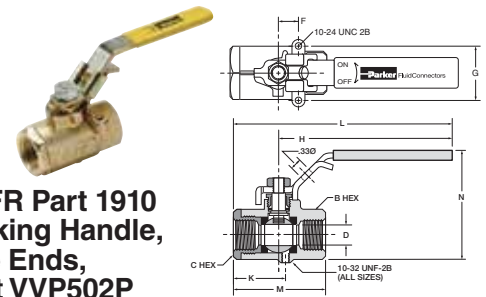

**OSHA 29 CFR Part 1910 Vented, Locking Handle, Female Pipe Ends, Panel Mount VVP502P**

PART NO.	PIPE THD. [PTF]	B HEX	C HEX	F	G	K	H	L	M	N	D FLOW Ø
VVP502P-4	1/4	15/16	15/16	.50	1.12	1.11	3.96	4.90	2.03	2.47	.375
VVP502P-6	3/8	15/16	15/16	.50	1.12	1.11	3.96	4.90	2.03	2.47	.375
VVP502P-8	1/2*	1-1/16	1-1/16	.50	1.12	1.23	3.96	5.00	2.20	2.58	.500
VVP502P-12	3/4**	1-1/4	1-5/16	.87	1.37	1.45	3.96	5.25	2.42	2.81	.685
VVP502P-16	1**	1-1/2	1-9/16	.87	1.37	1.58	3.96	5.34	2.75	3.08	.875

For use with 5/16" Ø shank lock

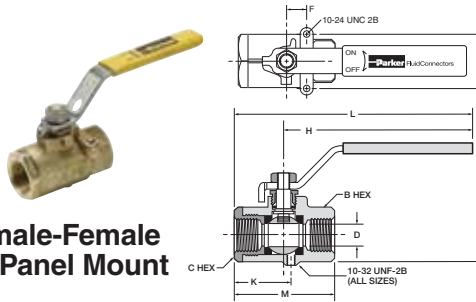

**Vented, Female-Female Pipe Ends, Panel Mount VV502P**

PART NO.	PIPE THD. [PTF]	B HEX	C HEX	F	G	K	H	L	M	N	D FLOW Ø
VV502P-4	1/4	15/16	15/16	.50	1.12	1.11	3.96	4.90	2.03	2.47	.375
VV502P-6	3/8	15/16	15/16	.50	1.12	1.11	3.96	4.90	2.03	2.47	.375
VV502P-8	1/2*	1-1/16	1-1/16	.50	1.12	1.23	3.96	5.00	2.20	2.58	.500
VV502P-12	3/4**	1-1/4	1-5/16	.87	1.37	1.45	3.96	5.25	2.42	2.81	.685
VV502P-16	1**	1-1/2	1-9/16	.87	1.37	1.58	3.96	5.34	2.75	3.08	.875

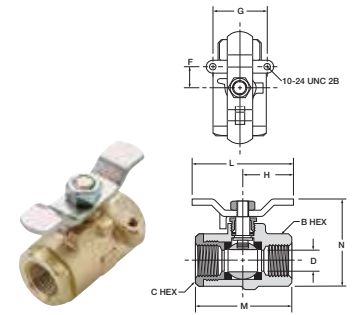

**Tee Handle, Female Pipe Ends, Panel Mount V502P-X-04**

PART NO.	PIPE THD. [PTF]	B HEX	C HEX	F	G	H	L	M	N	D FLOW Ø
V502P-4-04	1/4	15/16	15/16	.50	1.12	1.25	2.50	2.03	1.87	.375
V502P-6-04	3/8	15/16	15/16	.50	1.12	1.25	2.50	2.03	1.87	.375
V502P-8-04	1/2*	1-1/16	1-1/16	.50	1.12	1.25	2.50	2.20	1.98	.500
V502P-12-04	3/4**	1-1/4	1-5/16	.87	1.37	1.25	2.50	2.42	2.20	.685
V502P-16-04	1**	1-1/2	1-9/16	.87	1.37	1.25	2.50	2.75	2.48	.875

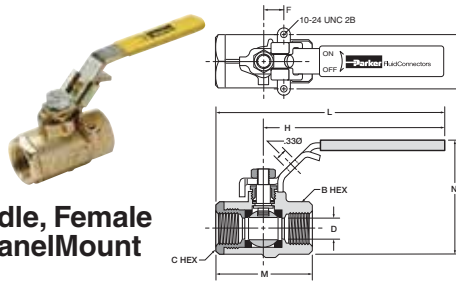

**Locking Handle, Female Pipe Ends, Panel Mount VP502P**

PART NO.	PIPE THD. [PTF]	B HEX	C HEX	F	G	H	L	M	N	D FLOW Ø
VP502P-4	1/4	15/16	15/16	.50	1.12	3.96	4.90	2.03	2.47	.375
VP502P-6	3/8	15/16	15/16	.50	1.12	3.96	4.90	2.03	2.47	.375
VP502P-8	1/2*	1-1/16	1-1/16	.50	1.12	3.96	5.00	2.20	2.58	.500
VP502P-12	3/4**	1-1/4	1-5/16	.87	1.37	3.96	5.25	2.42	2.81	.685
VP502P-16	1**	1-1/2	1-9/16	.87	1.37	3.96	5.34	2.75	3.08	.875

For use with 5/16" Ø shank lock

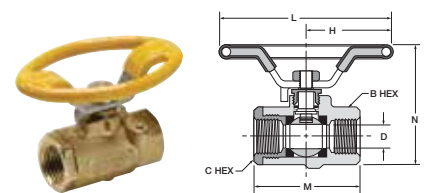

**Oval Handle, Female Pipe Ends, Panel Mount V502P-X-21**

PART NO.	PIPE THD. [PTF]	B HEX	C HEX	H	L	M	N	D FLOW Ø
V502P-4-21	1/4	15/16	15/16	1.74	3.49	2.03	2.38	.375
V502P-6-21	3/8	15/16	15/16	1.74	3.49	2.03	2.38	.375
V502P-8-21	1/2*	1-1/16	1-1/16	1.74	3.49	2.20	2.49	.500
V502P-12-21	3/4**	1-1/4	1-5/16	1.74	3.48	2.42	2.71	.685
V502P-16-21	1**	1-1/2	1-9/16	1.74	3.48	2.75	2.99	.875

\*PTF Special Short. \*\*PTF SPL Extra Short



# Ball Valve Brass Series 506



## Product Features:

- Forged brass body
- Chrome plated brass ball
- PTFE seats/seals
- Steel handle

## Style:

- V-Valve
- VP-Valve, padlocking handle

## Type:

- 506-Female/Female SAE J1926-1 Ports

## Material:

- P-Brass
- PN-Nickel plated

## Options:

- 01-Stainless Steel Ball & Stem
- 02-Stainless Steel Handle & Nut
- 03-Stainless Steel Ball, Stem, Handle & Nut
- 04-Tee Handle
- 08-Unmarked yellow vinyl handle cover
- 21-Oval Handle

## Specifications:

### Pressure Range:

- 600 WOG , Cold Non-shock
- Saturated Steam up to 150 psi
- Vacuum Service to 29 Inches Hg

### Temperature Range

- 0° to +350°F

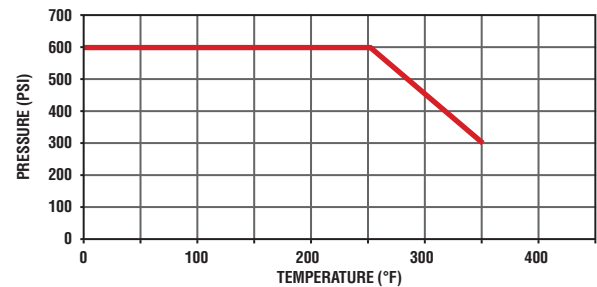

### Female/Female, Straight Thread O-Ring Port V506P

PART NO.	STRT. THREAD	B HEX	C HEX	H	L	M	N	D FLOW Ø
V506P-4	7/16-20	15/16	15/16	3.96	5.01	2.20	2.47	.375
V506P-6	9/16-18	15/16	15/16	3.96	5.07	2.26	2.47	.375
V506P-8	3/4-16	1-1/16	1-1/16	3.96	5.18	2.42	2.60	.500
V506P-12	1-1/16-12	1-1/4	1-5/16	3.96	5.87	3.46	2.81	.685
V506P-16	1-5/16-12	1-1/2	1-9/16	3.96	5.96	3.68	3.08	.875

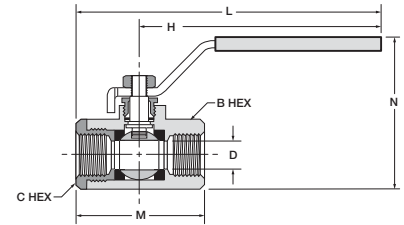

### Female/Female, Straight Thread O-Ring Port V506P-20, V506P-24, V506P-32

PART NO.	STRT. THREAD	B OCT	C OCT	H	L	M	N	D FLOW Ø
V506P-20	1 5/8-12	1.93	1.93	6.22	8.05	3.66	3.01	1.18
V506P-24	1 7/8-12	2.13	2.13	6.22	8.23	4.02	3.25	1.50
V506P-32	2 1/2-12	2.85	2.85	6.22	8.60	4.76	3.52	1.89

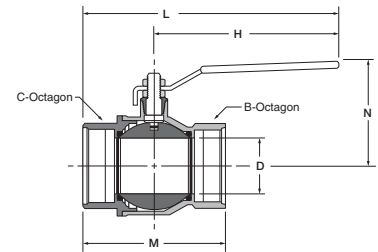

# Ball Valves

## Brass Series 509



### Product Features:

- Forged brass body
- Chrome plated brass ball
- PTFE seats/seals
- Steel handle

### Style:

- V-Valve

### Type:

- 509-Solder Ends

### Material:

- P-Brass

### Specifications:

#### Pressure Range:

- 600 WOG , Cold Non-shock
- Saturated Steam up to 150 psi

#### Temperature Range

- Nylon: 0° to +350°F
- Solder temperature not to exceed 470°F

### Solder Cup Ends V509P

PART NO.	TUBE SIZE	E	G	H	L	M	N	FLOW DIA. D
V509P-8	1/2	.630	.49	3.94	5.00	2.24	1.69	.55
V509P-12	3/4	.877	.75	4.72	6.10	2.85	1.97	.75
V509P-16	1	1.128	.90	4.72	6.40	3.35	2.13	.94
V509P-20	1 1/4	1.378	.96	6.22	8.13	3.82	3.01	1.18
V509P-24	1 1/2	1.628	1.10	6.22	8.46	4.49	3.25	1.50
V509P-32	2	2.128	1.34	6.22	8.94	5.43	3.52	1.89

FLOW DATA	
VALVE SIZE	CV
1/2"	26
3/4"	69
1"	91
1 1/4"	127
1 1/2"	299
2"	425

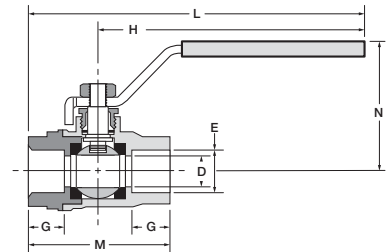

\*For these part numbers only the \* options are available.



# Ball Valves Brass Series 510



## Product Features:

- Forged brass body
- Chrome plated brass ball
- PTFE seats/seals
- Steel handle

## Style:

- V-Valve
- VP-Valve, padlocking handle

## Type:

- 510-Male/Female Straight Thread O-ring SAE J1926

## Material:

- P-Brass

## Options:

- 01-Stainless Steel Ball & Stem
- 02-Stainless Steel Handle & Nut
- 03-Stainless Steel Ball, Stem, Handle & Nut
- 04-Tee Handle
- 08-Unmarked yellow vinyl handle cover
- 21-Oval Handle

## Specifications:

### Pressure Range:

- 600 WOG , Cold Non-shock
- Saturated Steam up to 150 psi
- Vacuum Service to 29 Inches Hg
- Vented up to 250 psi

### Temperature Range

- 0° to +350°F

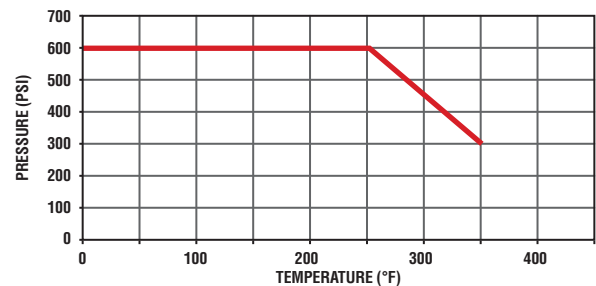

FLOW DATA	
VALVE SIZE	CV
1/4	.8
3/8	2.1
1/2	5.3
5/8	7.6
3/4	13.0
1	33.0

### Male-Female, Straight Thread O-Ring Port V510P

PART NO.	STRT. THREAD	B HEX	C HEX	H	L	M	N	D FLOW Ø
V510P-4	7/16-20	15/16	15/16	3.96	5.61	2.85	2.47	.188
V510P-6	9/16-18	15/16	15/16	3.96	5.68	2.92	2.47	.281
V510P-8	3/4-16	1-1/16	1-1/16	3.96	5.88	3.17	2.58	.422
V510P-10	7/8-14	1-1/4	1-5/16	3.96	6.31	3.90	2.81	.500
V510P-12	1-1/16-12	1-1/4	1-5/16	3.96	6.44	4.03	2.81	.656
V510P-16	1-5/16-12	1-1/2	1-9/16	3.96	6.56	4.28	3.08	.875

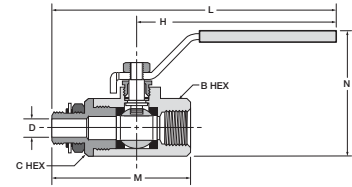

### Locking Handle, Straight Thread O-Ring Port VP510P

PART NO.	STRT. THREAD	B HEX	C HEX	H	L	M	N	D FLOW Ø
VP510P-4	7/16-20	15/16	15/16	3.96	5.61	2.85	2.47	.188
VP510P-6	9/16-18	15/16	15/16	3.96	5.68	2.92	2.47	.281
VP510P-8	3/4-16	1-1/16	1-1/16	3.96	5.88	3.17	2.58	.422
VP510P-10	7/8-14	1-1/4	1-5/16	3.96	6.31	3.90	2.81	.500
VP510P-12	1-1/16-12	1-1/4	1-5/16	3.96	6.44	4.03	2.81	.656

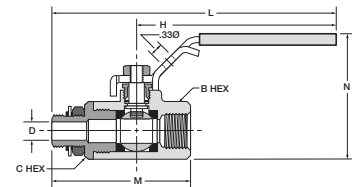

For use with 5/16" Ø shank lock

### Tee Handle, Straight Thread O-Ring Port V510P-X-04

PART NO.	STRT. THREAD	B HEX	C HEX	H	L	M	N	D FLOW Ø
V510P-4-04	7/16-20	15/16	15/16	1.25	2.50	2.85	1.87	.188
V510P-6-04	9/16-18	15/16	15/16	1.25	2.50	2.92	1.87	.281
V510P-8-04	3/4-16	1-1/16	1-1/16	1.25	2.50	3.17	1.98	.422
V510P-10-04	7/8-14	1-1/4	1-5/16	1.25	2.50	3.90	2.20	.500
V510P-12-04	1-1/16-12	1-1/4	1-5/16	1.25	2.50	4.03	2.20	.656
V510P-16-04	1-5/16-12	1-1/2	1-9/16	1.25	2.50	4.28	2.48	.875

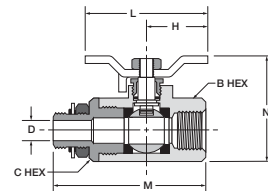

### Oval Handle, Straight Thread O-Ring Port V510P-X-21

PART NO.	STRT. THREAD	B & C HEX	H	L	M	N	D FLOW Ø
V510P-4-21	7/16-20	15/16	1.74	3.49	2.85	2.38	.188
V510P-6-21	9/16-18	15/16	1.74	3.49	2.92	2.38	.281
V510P-8-21	3/4-16	1 1/16	1.74	3.49	3.17	2.49	.422
V510P-12-21	1-1/16-12	1-1/4 (B)	1.75	3.49	4.03	2.71	.656
		1-5/16 (C)					

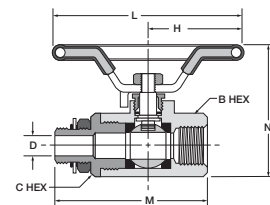

# Ball Valves

## Brass Series 520



### Product Features:

- Forged brass body
- Chrome plated brass ball
- PTFE seats/seals
- Fluorocarbon Stem O-rings
- Steel handle

### Style:

- V-Valve

### Type:

- 520-Female/Female NPT Ports

### Material:

- P-Brass

### Options:

- 04-Tee Handle

### Specifications:

#### Pressure Range:

- 600 WOG Cold Non-shock 1/4" – 2"
- 450 WOG, Cold Non-shock 2 1/2" – 3"
- Saturated Steam up to 150 psi
- Vacuum Service to 29 Inches Hg

#### Temperature Range

- -40° to +350°F

U.L. LISTED	
CATEGORY	
YSDT	LP-GAS SHUT-OFF VALVES
YRBX	FLAMMABLE LIQUID SHUT-OFF VALVES
YRPV	GAS SHUT-OFF VALVES
YQNZ	COMPRESSED GAS SHUT-OFF VALVES

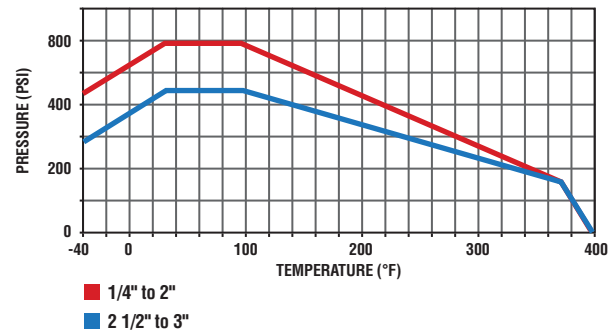

### Brass Ball Valve V520P

PART NO.	PIPE THREAD [NPT]	B OCTAGON	C OCTAGON	H	L	M	N	D FLOW Ø
V520P-4	1/4-18	.79	.79	3.94	4.83	1.77	1.50	.310
V520P-6	3/8-18	.79	.79	3.94	4.83	1.77	1.50	.400
V520P-8	1/2-14	.98	.98	3.94	5.10	2.32	1.69	.600
V520P-12	3/4-14	1.22	1.22	4.72	5.98	2.52	1.97	.790
V520P-16	1-11.5	1.57	1.57	4.72	6.32	3.19	2.13	1.000
V520P-20	1-1/4	1.93	1.93	6.22	8.05	3.66	2.82	1.180
V520P-24	1-1/2	2.13	2.13	6.22	8.23	4.02	3.06	1.570
V520P-32	2	2.69	2.69	6.22	8.58	4.76	3.33	2.000
V520P-40	2-1/2	3.35	3.35	10.04	13.11	6.14	5.20	2.520
V520P-48	3	3.89	3.89	10.04	13.52	6.97	5.51	3.000

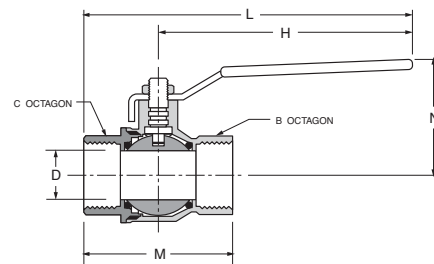



# Ball Valves Brass Series 533 3-Way Diversion / Series 540 4-Way

### Product Features:

- Forged brass body
- Chrome plated brass ball
- PTFE seats/seals
- Steel handle

### Style:

- V-Valve
- VP-Valve, padlocking handle

### Type:

- 533 3-Way Diversion
- 540 4-Way

### Material:

- P-Brass

### Options:

- 02-Stainless Steel Handle & Nut
- 08-Unmarked yellow vinyl handle cover

### Specifications:

#### Pressure Range:

- 400 psi
- Vacuum Service to 29 Inches Hg

#### Temperature Range

- -20° to +350°F

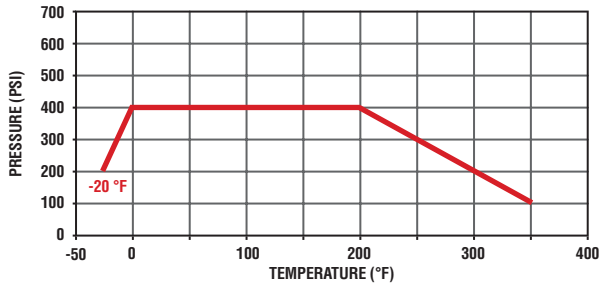

V540P FLOW INFORMATION	
POINTER OVER	FLOW PATH
A	A TO E
OFF	CLOSED
C	C TO E
D	D TO E

### V540P Handle Positions

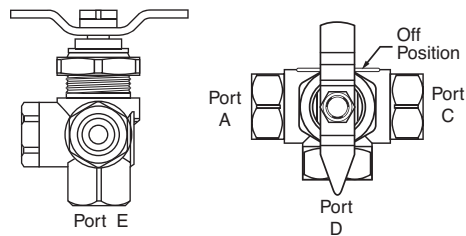

### V533P Handle Positions

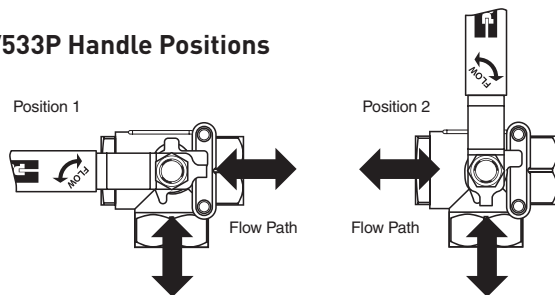

### Female-Female-Female Pipe Ends V533P

PART NO.	PIPE THD (PTF)	B HEX	E	F	G	H	K	L	M	N	FLOW DIA. D
V533P-4	1/4	15/16	.50	1.08	1.12	3.96	1.03	2.47	2.03	1.94	.375
V533P-6	3/8	15/16	.50	1.08	1.12	3.96	1.03	2.47	2.03	1.94	.375
V533P-8	1/2	1-1/16	.50	1.18	1.12	3.96	1.11	2.58	2.20	1.98	.500
V533P-12	3/4	1-1/4	.87	1.43	1.37	3.96	1.42	2.90	2.83	2.17	.685
V533P-16	1	1-9/16	.87	1.62	1.37	3.96	1.58	3.21	3.16	2.32	.875

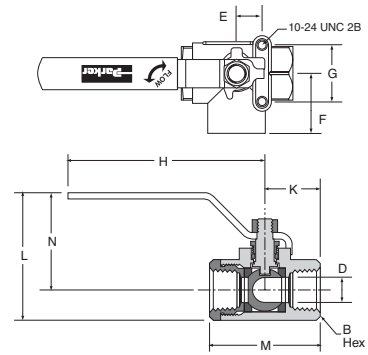

### Female-Female-Female-Female Pipe Ends V540P

PART NO.	PIPE THD (PTF)	B HEX	E	F	G	H	K	L	M	N	FLOW DIA. D
V540P-4	1/4	7/8	.32	1.00	1.76	1.25	1.98	2.49	.52	1.07	.250

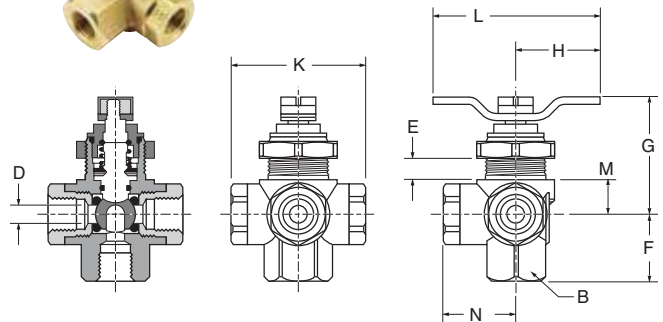

# Ball Valves

## Brass Series 590/591



### Product Features:

- Forged brass body
- Chrome plated brass ball
- PTFE seats/seals
- Steel handle

### Style:

- V-Valve

### Type:

- 590-Male/Female
- 591-Male/Female

### Material:

- P-Brass

### Options:

- 04-Lever Handle
- 08-Unmarked yellow vinyl handle cover

### Specifications:

#### Pressure Range:

- 250 psi
- Saturated Steam up to 150 psi
- Vacuum Service to 29 Inches Hg

#### Temperature Range

- -50° to +350°F

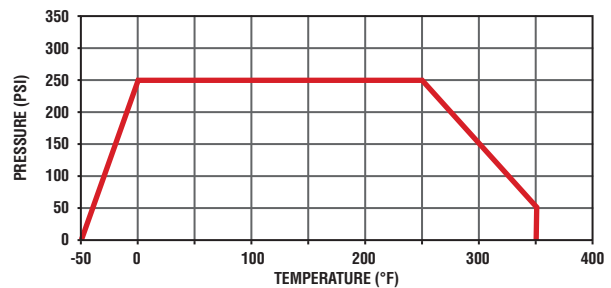

### 90° Flow, Male-Female Pipe Ends V590P

PART NO.	PIPE PTF THREAD	HEX	H	K	L	M	N	D FLOW Ø
V590P-4	1/4	15/16	1.25	1.08	2.50	1.00	2.42	.375
V590P-6	3/8	15/16	1.25	1.09	2.50	1.00	2.43	.375
V590P-8	1/2*	1-1/16	1.25	1.30	2.50	1.08	2.67	.500
V590P-16	1**	1-9/16"	1.30	1.90	2.60	1.38	3.62	.750

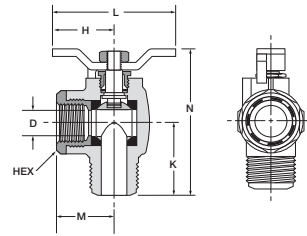

### Lever Handle, 90° Flow, Male-Female Pipe Ends V590P-X-04

PART NO.	PIPE PTF THREAD	HEX	H	K	L	M	N	D FLOW Ø
V590P-4-04	1/4	15/16	3.96	1.08	4.96	1.00	3.02	.375
V590P-6-04	3/8	15/16	3.96	1.09	4.96	1.00	3.03	.375
V590P-8-04	1/2*	1-1/16	3.80	1.30	4.88	1.08	2.95	.500
V590P-16-04	1**	1-9/16"	3.96	1.90	5.34	1.38	4.17	.750

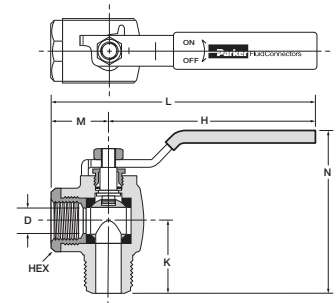

### 90° Flow, Male-Male Pipe Ends V591P

PART NO.	PIPE THREAD	HEX	H	K	L	M	N	D FLOW Ø
V591P-4	1/4	15/16	1.25	1.08	2.50	1.56	2.42	.375
V591P-6	3/8	15/16	1.25	1.09	2.50	1.56	2.43	.375
V591P-8	1/2	1-1/16	1.25	1.30	2.50	1.84	2.67	.500

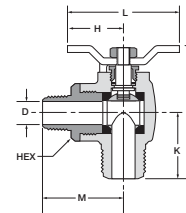

### Lever Handle, 90° Flow, Male-Male Pipe Ends V591P-X-04

PART NO.	PIPE THREAD	HEX	H	K	L	M	N	D FLOW Ø
V591P-4-04	1/4	15/16	3.96	1.08	5.52	1.56	3.02	.375
V591P-6-04	3/8	15/16	3.96	1.09	5.52	1.56	3.03	.375
V591P-8-04	1/2	1-1/16	3.80	1.30	5.64	1.84	2.95	.500

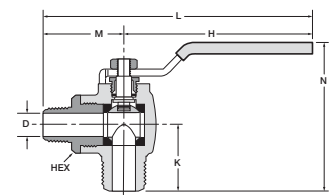

\*PTF Special Short. \*\*PTF SPL Extra Short



# Ball Valves

## Brass Series 500HB



### Product Features:

- Forged brass body
- Chrome plated brass ball
- PTFE seats/seals
- Steel handle

### Style:

- V-Valv

### Type:

- 500HB-Female/Beaded Hose Barb

### Material:

- P-Brass

### Specifications:

#### Pressure Range:

- 150 psi WOG, Cold Non-Shock
- Saturated Steam up to 150 psi
- Vacuum Service to 29 Inches Hg

#### Temperature Range

- 0° to +350°F

### Brass Hose Barb Ball Valve V500P-HB

PART NO.	PORT 1	PORT 2 PTF	B HEX	C HEX	H	L	M	N	FLOW DIA. D
V500P-12-16HB	1	3/4*	1-1/4	1-5/16	3.96	6.25	3.41	2.81	.685

\*PTF special extra short

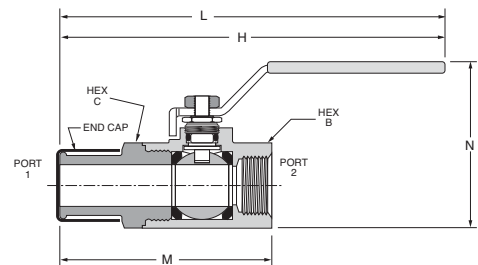

# Ball Valves

## Brass Series 600



### Product Features:

- Forged brass body
- Chrome plated brass ball
- PTFE seats/seals
- Fluorocarbon O-rings
- Steel handle

### Style:

- V-Valve

### Type:

- 600-Three Position
- 633-Two Position

### Material:

- P-Brass

### Specifications:

#### Pressure Range:

- 150 psi
- Vacuum Service to 29 Inches Hg

#### Temperature Range

- 0° to +250°F

### Series 600 Handle Positions

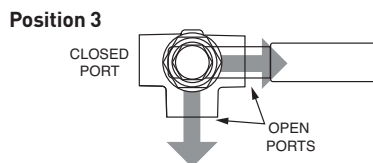
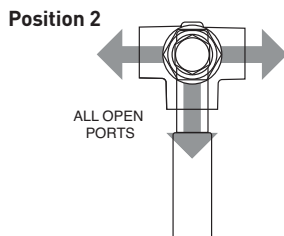
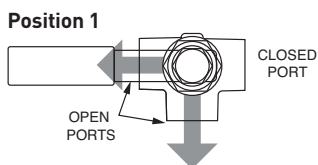

### Series 633 Handle Positions

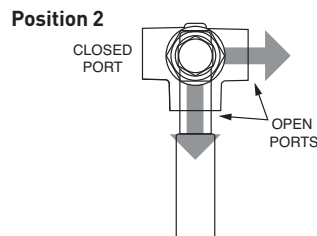
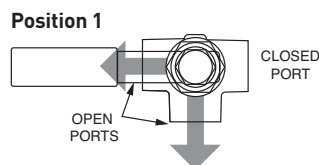

This valve can be used on applications where a fluid return or spillback is required. For use on construction equipment, chemical processing, diesel engines, filter banks, pumps and specialized industrial machinery.

NOTE: Diversion valves do not have off positions, therefore, the center ports can not be used for shut-off purposes.

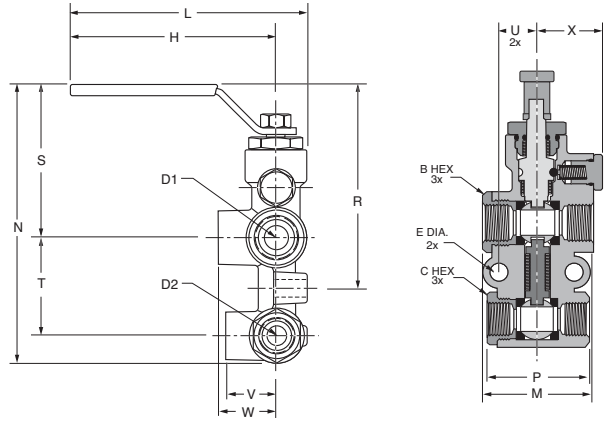

**Six Port Diversion Brass Valve V600P**

PIPE THD. PART NO.	PIPE THD. TOP PORT SPL SHORT	BOTTOM PORT PTF	B HEX	C HEX	D1 FLOW	D2 FLOW	E	H	L	M	N	P	R	S	T	U	V	W	X
V600P-8-6	1/2	3/8	1 1/16	15/16	.500	.375	.34	3.96	4.56	2.20	5.43	2.03	3.98	2.99	1.91	.73	.98	1.12	1.31

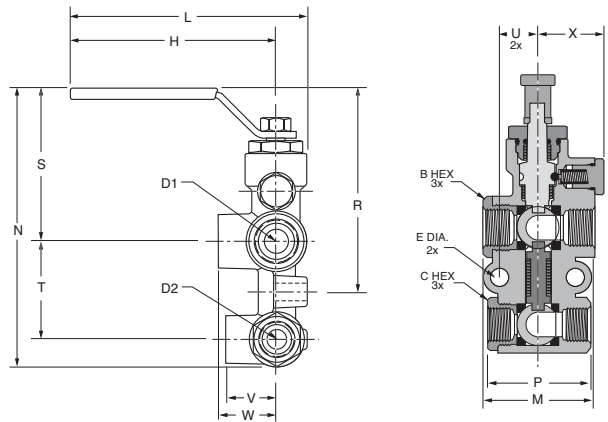

**Six Port Diversion Brass Valve V633P**

PIPE THD. PART NO.	PIPE THD. TOP PORT SPL SHORT	BOTTOM PORT PTF	B HEX	C HEX	D1 FLOW	D2 FLOW	E	H	L	M	N	P	R	S	T	U	V	W	X
V633P-8-6	1/2	3/8	1 1/16	15/16	.500	.375	.34	3.96	4.56	2.20	5.43	2.03	3.98	2.99	1.91	.73	.98	1.12	1.31



# Ball Valves

## Carbon Steel Series 500CS/502CS

### Product Features:

- Carbon Steel Phosphate Coated body
- Steel ball
- PTFE seats/seals
- Steel handle

### Style:

- V-Valve
- VP-Valve, padlocking handle

### Type:

- 500-Female/Female
- 502-Female/Female

### Material:

- CS-Carbon Steel

### Options:

- 04-Tee Handle
- 21-Oval Handle

### Specifications:

#### Pressure Range:

- 2000 psi: 1/4" – 1"
- 1500 psi: 1 1/4" – 2"
- Saturated Steam up to 150 psi

#### Temperature Range

- -20° to +425°F

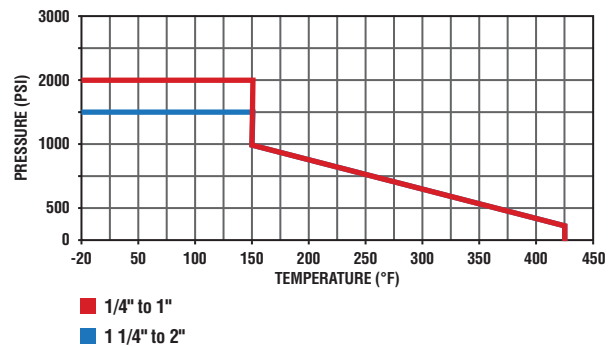

FLOW DATA	
VALVE SIZE	CV
1/4	6.0
3/8	12.8
1/2	15.0
3/4	23.0
1	36.0
1-1/4	44.0
1-1/2	64.0
2	114.0

### Female-Female Pipe Ends V500CS

PART NO.	PIPE THREAD	B HEX	C HEX	H	L	M	N	D FLOW Ø
V500CS-4	1/4	1-1/16	15/16	3.78	1.00	2.00	1.63	.400
V500CS-6	3/8	1-1/16	15/16	3.78	1.00	2.00	1.63	.400
V500CS-8	1/2	1-1/4	1-1/16	3.78	1.25	2.37	1.73	.540
V500CS-12	3/4	1-5/8	1-3/8	5.10	1.50	2.90	2.08	.680
V500CS-16	1	2	1-5/8	5.10	1.76	3.41	2.30	.880

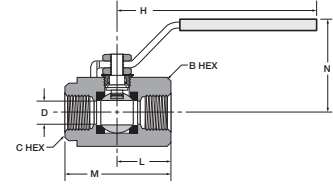

### Female-Female Pipe Ends, Panel Mount V502CS

PART NO.	PIPE THD	B HEX	C HEX	F	G	H	L	M	N	FLOW DIA. D
V502CS-20	1-1/4	2	2-1/4	.94	1.50	6.10	1.87	3.80	2.76	1.000
V502CS-24	1-1/2	2-5/16	2-1/2	.94	1.50	6.10	2.27	4.55	2.98	1.250
V502CS-32	2	2-3/4	3	1.03	2.00	8.60	2.42	4.83	3.54	1.500

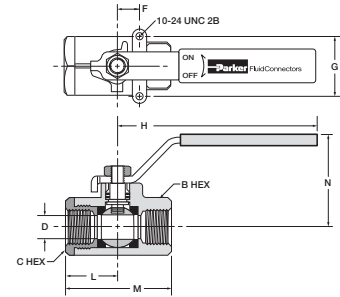

### Locking Handle, Female Pipe Ends VP500CS

PART NO.	PIPE THD	B HEX	C HEX	H	L	M	N	D FLOW Ø
VP500CS-4	1/4	1-1/16	15/16	4.13	1.00	2.00	2.23	.400
VP500CS-6	3/8	1-1/16	15/16	4.13	1.00	2.00	2.23	.400
VP500CS-8	1/2	1-1/4	1-1/16	4.13	1.25	2.37	2.33	.540
VP500CS-12	3/4	1-5/8	1-3/8	5.00	1.50	2.90	2.80	.680
VP500CS-16	1	2	1-5/8	5.00	1.76	3.41	2.97	.880

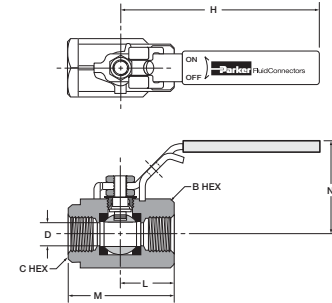

### Locking Handle, Female Pipe Ends, Panel Mount VP502CS

PART NO.	PIPE THD	B HEX	C HEX	F	G	H	L	M	N	FLOW DIA. D
VP502CS-20	1-1/4	2	2-1/4	.94	1.50	7.50	1.87	3.80	3.15	1.000
VP502CS-24	1-1/2	2-5/16	2-1/2	.94	1.50	7.50	2.27	4.55	3.37	1.250
VP502CS-32	2	2-3/4	3	1.03	2.00	8.75	2.42	4.83	3.46	1.500

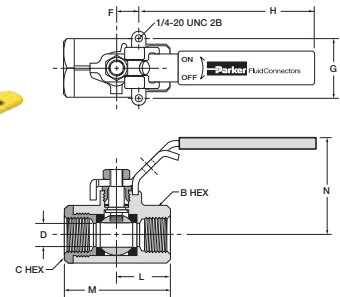

### Tee Handle, Female Pipe Ends V500CS-X-04

PART NO.	PIPE THD	B HEX	C HEX	H	L	M	N	D FLOW Ø
V500CS-4-04	1/4	1-1/16	15/16	2.16	1.08	2.00	1.41	.400
V500CS-6-04	3/8	1-1/16	15/16	2.16	1.08	2.00	1.41	.400
V500CS-8-04	1/2	1-1/4	1-1/16	2.90	1.45	2.37	1.66	.540
V500CS-12-04	3/4	1-5/8	1-3/8	3.63	1.81	2.90	2.06	.680
V500CS-16-04	1	2	1-5/8	3.63	1.81	3.41	2.23	.880

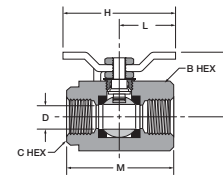

### Oval Handle, Female Pipe Ends V500CS-X-21

PART NO.	PIPE THD	B HEX	C HEX	H	L	M	N	D FLOW Ø
V500CS-4-21	1/4	1-1/16	15/16	3.50	1.00	2.00	1.66	.400
V500CS-6-21	3/8	1-1/16	15/16	3.50	1.00	2.00	1.66	.400
V500CS-8-21	1/2	1-1/4	1-1/16	3.50	1.13	2.37	1.76	.540
V500CS-12-21	3/4	1-5/8	1-3/8	5.00	1.46	2.90	2.13	.680
V500CS-16-21	1	2	1-5/8	5.00	1.58	3.41	2.29	.880

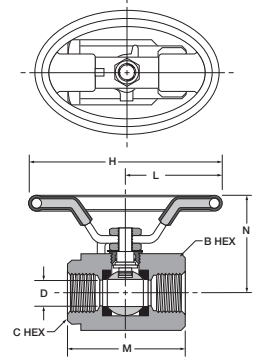

### Oval Handle, Female Pipe Ends, Panel Mount V502CS-X-21

PART NO.	PIPE THD	B HEX	C HEX	F	G	H	L	M	N	FLOW DIA. D
V502CS-20-21	1-1/4	2	2-1/4	.94	1.50	5.07	2.53	3.80	3.04	1.000
V502CS-24-21	1-1/2	2-5/16	2-1/2	.94	1.50	5.07	2.53	4.55	3.26	1.250
V502CS-32-21	2	2-3/4	3	1.03	2.00	6.50	3.25	4.83	3.57	1.500

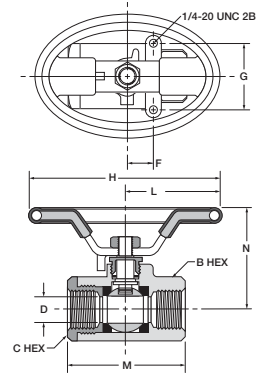



# Ball Valves

## Carbon Steel Series 506CS

### Product Features:

- Carbon Steel Phosphate Coated body
- Steel ball
- PTFE seats/seals
- Steel handle

### Style:

- V-Valve
- VP-Valve, padlocking handle

### Type:

- 506-Female/Female SAE Straight Thread Ports

### Material:

- CS-Carbon Steel

### Options:

- 04-Tee Handle
- 21-Oval Handle

### Specifications:

#### Pressure Range:

- 3000 psi
- Saturated Steam up to 150 psi

#### Temperature Range

- -20° to +425°F

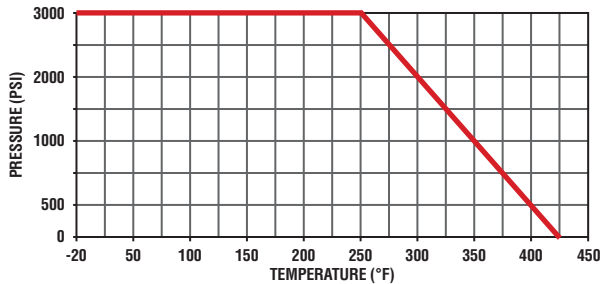

FLOW DATA	
VALVE SIZE	CV
1/4	6.0
3/8	12.0
1/2	15.0
3/4	34.0
1	54.0

### Female-Female SAE Straight Thread Ports V506CS

PART NO.	STRAIGHT THREAD	B HEX	C HEX	H	L	M	N	D FLOW Ø
V506CS-4	7/16-20	1-1/16	15/16	3.78	1.00	2.00	1.63	.400
V506CS-6	9/16-18	1-1/16	15/16	3.78	1.00	2.00	1.63	.400
V506CS-8	3/4-16	1-5/8	1-1/4	4.78	1.32	2.84	2.16	.500
V506CS-12	1-1/16-12	1-7/8	1-5/8	4.78	1.66	3.71	2.35	.750
V506CS-16	1-5/16-12	2-1/2	2-1/8	6.10	1.88	4.15	2.85	1.000

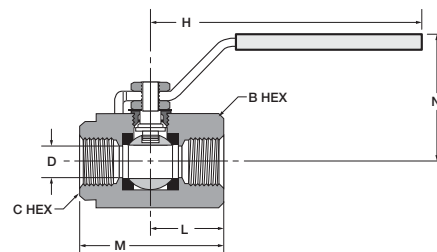





# Ball Valves

## Carbon Steel Series 500HP, 506HP

### Product Features:

- Carbon Steel Phosphate Coated body
- Steel ball
- Delrin with Molybdenum Disulphide Seats
- Nitrile O-rings Stem Seals
- Steel handle

### Style:

- V-Valve
- VP-Valve, padlocking handle

### Type:

- 500-Female/Female NPT Ports
- 506-Female/Female SAE Straight Thread Ports

### Material:

- HP-High Pressure Carbon Steel

### Specifications:

#### Pressure Range:

- 6000 psi

#### Temperature Range

- -10° to +210°

Pressure Drop (PSI)

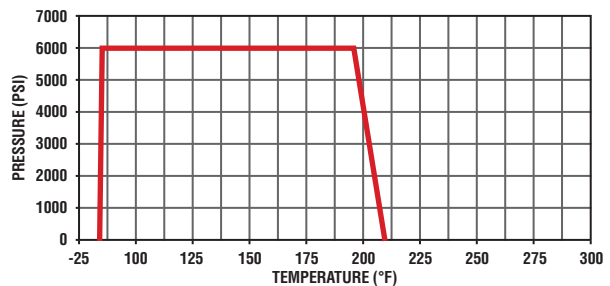
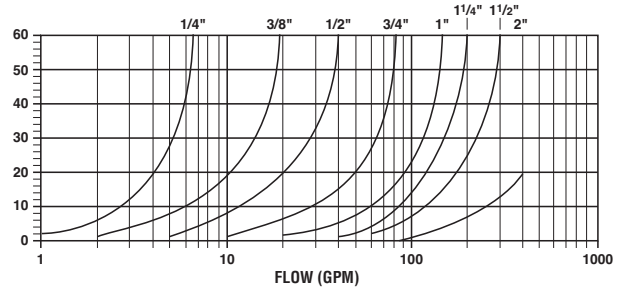

### 6000 PSI Female-Female Pipe Ends V500HP-X

PART NO.	PIPE THREAD (NPT)	B	C	H	L	M	N	FLOW DIA. D
V500HP-4	1/4-18	.69	1.38	4.50	1.44	2.75	2.94	.240
V500HP-6	3/8-18	.56	1.50	4.50	1.69	2.88	3.06	.390
V500HP-8	1/2-14	.75	1.63	4.50	1.88	3.38	3.19	.510
V500HP-12	3/4-14	.69	2.25	7.00	2.41	3.81	4.69	.790
V500HP-16	1-11.5	.94	2.50	7.00	2.56	4.50	4.94	.950

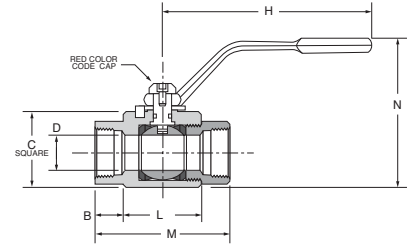

### 6000 PSI Female-Female Pipe Ends V500HP-X (LARGE)

PART NO.	PIPE THREAD (NPT)	B	C	H	L	M	N	FLOW DIA. D
V500HP-20	1 1/4-11.5	.85	3.25	10.00	3.15	4.84	6.31	1.26
V500HP-24	1 1/2-11.5	.99	3.75	10.00	3.35	5.33	6.76	1.50
V500HP-32	2-11.5	1.30	4.50	10.00	3.94	6.54	7.42	1.89

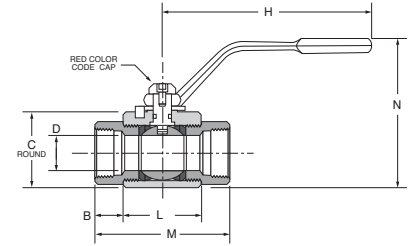

### 6000 PSI Locking-Female-Female Pipe Ends VP500HP-X

PART NO.	PIPE THREAD (NPT)	B	C	H	L	M	N	FLOW DIA. D
VP500HP-4	1/4-18	.69	1.38	4.50	1.44	2.75	2.94	.240
VP500HP-6	3/8-18	.56	1.50	4.50	1.69	2.88	3.06	.390
VP500HP-8	1/2-14	.75	1.63	4.50	1.88	3.38	3.19	.510
VP500HP-12	3/4-14	.69	2.25	7.00	2.41	3.81	4.69	.790
VP500HP-16	1-11.5	.94	2.50	7.00	2.56	4.50	4.94	.950

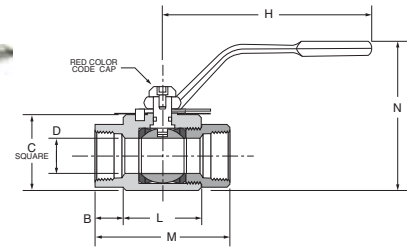

### 6000 PSI Locking-Female-Female Pipe Ends VP500HP-X (LARGE)

PART NO.	PIPE THREAD (NPT)	B	C	H	L	M	N	FLOW DIA. D
VP500HP-20	1 1/4-11.5	.85	3.25	10.00	3.15	4.84	6.31	1.26
VP500HP-24	1 1/2-11.5	.99	3.75	10.00	3.35	5.33	6.76	1.50
VP500HP-32	2-11.5	1.30	4.50	10.00	3.94	6.54	7.42	1.89

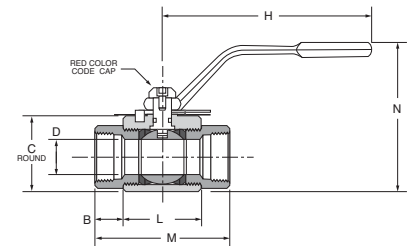

### 6000 PSI Female-Female Straight Thread Ends V506HP-X

PART NO.	SAE J1926-1 THREAD	B	C	H	L	M	N	FLOW DIA. D
V506HP-4	7/16-20 UNF	.69	1.38	4.50	1.44	2.75	2.94	.240
V506HP-6	9/16-18 UNF	.56	1.50	4.50	1.69	2.88	3.06	.390
V506HP-8	3/4-16 UNF	.75	1.63	4.50	1.88	3.38	3.19	.510
V506HP-12	1 1/16-12 UNF	.69	2.25	7.00	2.41	3.81	4.69	.790
V506HP-16	1 5/16-12 UNF	.94	2.50	7.00	2.56	4.50	4.94	.950

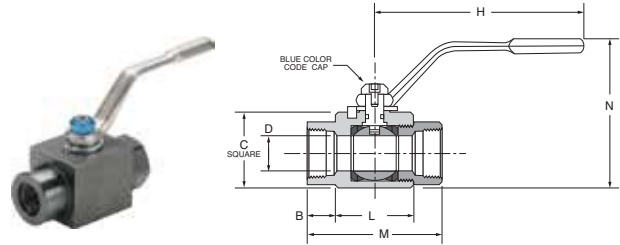

### 6000 PSI Female-Female Straight Thread Ends V506HP-X (LARGE)

PART NO.	SAE J1926-1 THREAD	B	C	H	L	M	N	FLOW DIA. D
V506HP-20	1 5/8-12 UNF	.85	3.25	10.00	3.15	4.84	6.31	1.26
V506HP-24	1 7/8-12 UNF	.99	3.75	10.00	3.35	5.33	6.76	1.50
V506HP-32	2 1/2-12 UNF	1.30	4.50	10.00	3.94	6.54	7.42	1.89

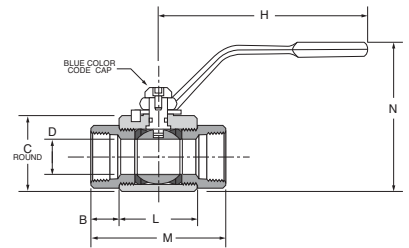

### 6000 PSI Locking-Female-Female Straight Thread Ends VP506HP-X

PART NO.	SAE J1926-1 THREAD	B	C	H	L	M	N	FLOW DIA. D
VP506HP-4	7/16-20 UNF	.69	1.38	4.50	1.44	2.75	2.94	.240
VP506HP-6	9/16-18 UNF	.56	1.50	4.50	1.69	2.88	3.06	.390
VP506HP-8	3/4-16 UNF	.75	1.63	4.50	1.88	3.38	3.19	.510
VP506HP-12	1 1/16-12 UNF	.69	2.25	7.00	2.41	3.81	4.69	.790
VP506HP-16	1 5/16-12 UNF	.94	2.50	7.00	2.56	4.50	4.94	.950

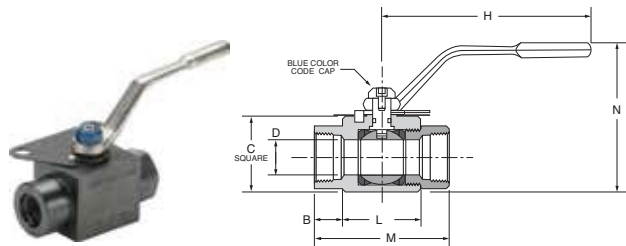

### 6000 PSI Locking-Female-Female Straight Thread Ends VP506HP-X (LARGE)

PART NO.	SAE J1926-1 THREAD	B	C	H	L	M	N	FLOW DIA. D
VP506HP-20	1 5/8-12 UNF	.85	3.25	10.00	3.15	4.84	6.31	1.26
VP506HP-24	1 7/8-12 UNF	.99	3.75	10.00	3.35	5.33	6.76	1.50
VP506HP-32	2 1/2-12 UNF	1.30	4.50	10.00	3.94	6.54	7.42	1.89

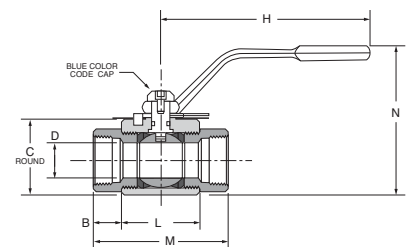



# Ball Valves

## Stainless Steel Series 501SS

### Product Features:

- CF-8M Stainless Steel body
- Stainless Steel ball
- PTFE Seats/Seals
- Stainless Steel handle
- Silicone Free

### Material:

- SS – Stainless Steel

### Options

- 20-Short Handle
- 21-Oval Handle
- 35-Welded Retainer Nut

### Specifications:

#### Pressure Range:

- 2000 psi
- Vacuum service 28 inches Hg

#### Temperature Range

- 0° to +400°F

### Style:

- V-Valve

### Type:

- 501-Male/Female NPT Ports

### Approvals

- Meets material requirements of NACE MR-01-75

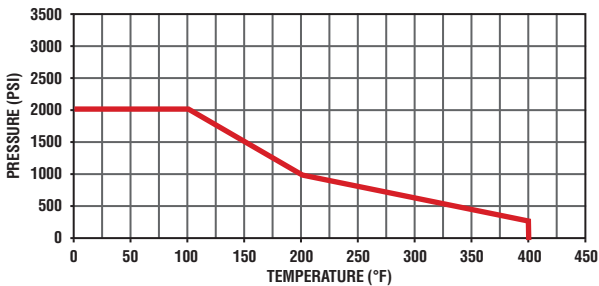

FLOW DATA	
VALVE SIZE	CV
1/4	4.0
3/8	6.0
1/2	14.0
3/4	35.0
1	54.0

### Mounting Detail

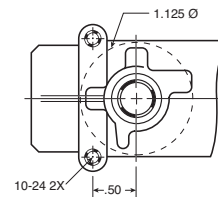

### Male-Female Pipe Ends V501SS

PART NO.	PIPE THREAD [NPT]	HEX	F	G	L	M	N	D FLOW Ø
V501SS-4	1/4	15/16	.50	1.12	5.60	2.65	1.97	.280
V501SS-6	3/8	15/16	.50	1.12	5.60	2.65	1.97	.375
V501SS-8	1/2	1-1/16	.50	1.12	5.85	3.05	2.00	.500
V501SS-12	3/4	1-3/8	.88	1.37	7.27	3.85	2.55	.720
V501SS-16	1	1-5/8	.88	1.37	7.48	4.25	2.68	.940

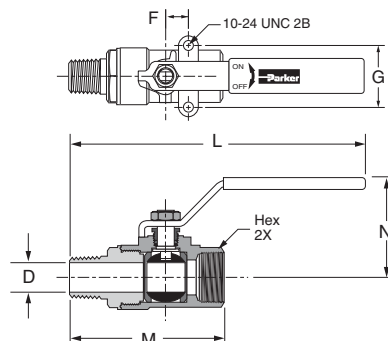

# Ball Valves

## Stainless Steel Series 502SS



### Product Features:

- CF-8M Stainless Steel body
- Stainless Steel ball
- PTFE Seats/Seals
- Stainless Steel handle
- Silicone Free

### Style:

- V-Valve
- VP-Valve, Padlocking

### Type:

- 502-Panel Mount Female/ Female NPT Ports

### Material:

- SS – Stainless Steel

### Options

- 20-Short Handle
- 21-Oval Handle
- 35-Welded Retainer Nut

### Specifications:

#### Pressure Range:

- 2000 psi: 1/4" – 1"
- 1500 psi: 1 1/4" – 2"
- Vacuum service 28 inches Hg

#### Temperature Range

- 0° to +400°F

### Approvals

- Meets material requirements of NACE MR-01-75

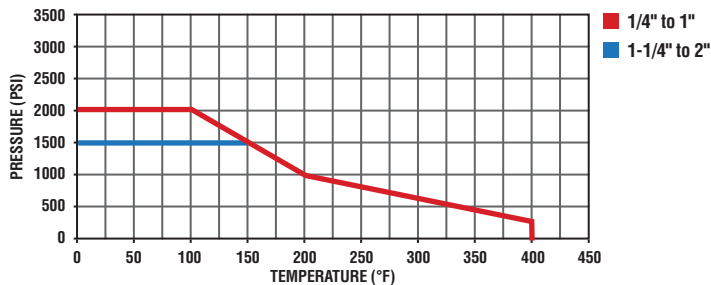

FLOW DATA		MOUNTING HOLE DIAMETER	
VALVE SIZE	CV	VALVE SIZE	DIA. IN.
1/4	4.0	1/4	1.125
3/8	6.0	3/8	1.125
1/2	14.0	1/2	1.125
3/4	35.0	3/4	1.500
1	54.0	1	1.500
1 1/4	74.0	1 1/4	1.875
1 1/2	120.0	1 1/2	1.875
2	226.0	2	1.875

### Mounting Detail

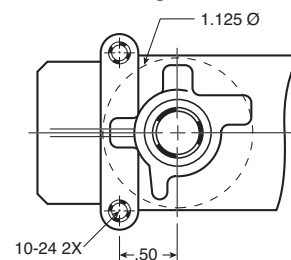

Note: Periodically check the adjustable packing nut and tighten as required.

## Female Pipe Ends, Panel Mount V502SS

PART NO.	PIPE THD (NPT)	B/C HEX	F	G	H	I THREAD	L	M	N	PANEL FLOW DIA. D	HOLE DIA.
V502SS-4	1/4	15/16	.500	1.125	4.00	10-24 UNC	5.03	2.07	2.52	.380	1.125
V502SS-6	3/8	15/16	.500	1.125	4.00	10-24 UNC	5.03	2.07	2.52	.380	1.125
V502SS-8	1/2	1-1/16	.500	1.125	4.00	10-24 UNC	5.13	2.27	2.65	.500	1.125
V502SS-12	3/4	1-3/8	.875	1.375	5.00	10-24 UNC	6.67	3.35	3.46	.790	1.500
V502SS-16	1	1-5/8	.875	1.375	5.00	10-24 UNC	6.77	3.54	3.74	1.000	1.500
V502SS-20	1-1/4	2	1.000	1.500	7.00	1/4-20 UNC	9.00	4.00	4.55	1.250	2.000
V502SS-24	1-1/2	2-3/8	1.000	1.500	7.00	1/4-20 UNC	7.19	4.38	5.42	1.500	2.000
V502SS-32	2	3	1.000	1.500	7.00	1/4-20 UNC	9.75	5.50	5.68	2.000	2.000

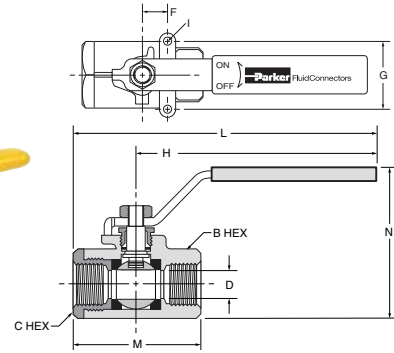

## Short Handle, Female Pipe Ends, Panel Mount V502SS-X-20

PART NO.	PIPE THREAD (NPT)	B/C HEX	G	H	L	M	N	FLOW DIA. D
V502SS-4-20	1/4	15/16	1.12	2.28	3.32	2.07	2.53	.375
V502SS-6-20	3/8	15/16	1.12	2.28	3.32	2.07	2.53	.375
V502SS-8-20	1/2	1-1/16	1.12	2.22	3.37	2.25	2.63	.500

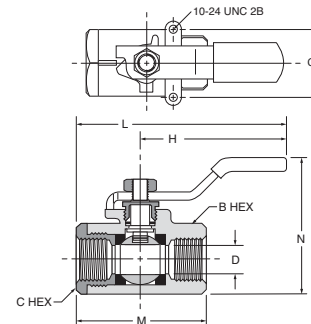

## Locking Handle, Female Pipe Ends, Panel Mount VP502SS

PART NO.	PIPE THD (NPT)	B/C HEX	F	G	H	I THREAD	L	M	N	PANEL FLOW DIA. D	HOLE DIA.
VP502SS-4	1/4	15/16	.500	1.125	4.00	10-24 UNC	5.03	2.07	2.52	.380	1.125
VP502SS-6	3/8	15/16	.500	1.125	4.00	10-24 UNC	5.03	2.07	2.52	.380	1.125
VP502SS-8	1/2	1-1/16	.500	1.125	4.00	10-24 UNC	5.13	2.27	2.65	.500	1.125
VP502SS-12	3/4	1-3/8	.875	1.375	5.00	10-24 UNC	6.67	3.35	3.46	.790	1.500
VP502SS-16	1	1-5/8	.875	1.375	5.00	10-24 UNC	6.77	3.54	3.74	1.000	1.500
VP502SS-20	1-1/4	2	1.000	1.500	7.00	1/4-20 UNC	9.00	4.00	4.55	1.250	2.000
VP502SS-24	1-1/2	2-3/8	1.000	1.500	7.00	1/4-20 UNC	7.19	4.38	5.42	1.500	2.000
VP502SS-32	2	3	1.000	1.500	7.00	1/4-20 UNC	9.75	5.50	5.68	2.000	2.000

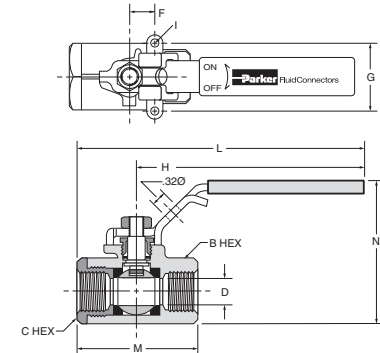

## Oval Handle, Female Pipe Ends, Panel Mount V502SS-X-21

PART NO.	PIPE THD (NPT)	B/C HEX	G	H	L	I THREAD	M	N	PANEL FLOW DIA. D	HOLE DIA.
V502SS-4-21	1/4	15/16	1.125	1.74	3.48	10-24 UNC	2.07	2.43	.380	1.125
V502SS-6-21	3/8	15/16	1.125	1.74	3.48	10-24 UNC	2.07	2.43	.380	1.125
V502SS-8-21	1/2	1-1/16	1.125	1.74	3.48	10-24 UNC	2.27	2.54	.500	1.125
V502SS-12-21	3/4	1-3/8	1.375	2.68	5.36	10-24 UNC	3.35	3.45	.790	1.500
V502SS-16-21	1	1-5/8	1.375	2.68	5.36	10-24 UNC	3.54	3.74	1.000	1.500

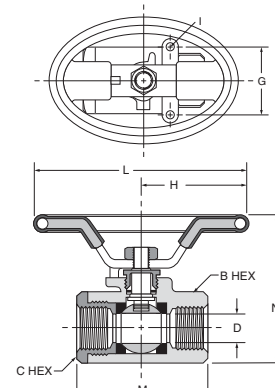

# Ball Valves Micro Series 708/709



### Product Features:

- Brass Body
- Chrome Plated Brass Ball
- PTFE Seats/Seals
- Nitrile Stem Seal
- Chrome Plated Steel Handle

### Style:

- MV-Micro Valve

### Type:

- 708-Male/Female
- 709-Female/Female

### Specifications:

#### Pressure Range:

- Up to 500 psi
- Vacuum service 29 inches Hg

#### Temperature Range

- -35° to +300°F

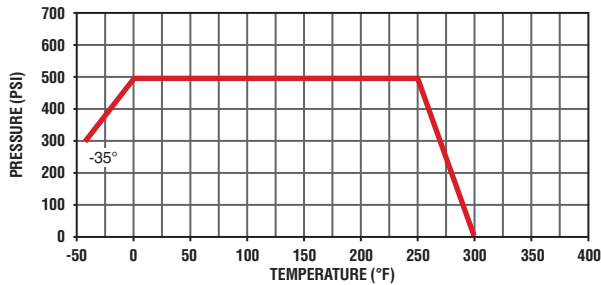

FLOW DATA		
VALVE SIZE	MV708 CV	MV709 CV
1/4	.95	.95

### Male-Female Pipe Ends, Mini Ball Valve MV708

PART NO.	PIPE THREAD	B HEX	H	L	M	N	P	FLOW DIA. D
MV708-2	1/8	9/16	1.18	.63	1.62	.93	.38	.180
MV708-4	1/4	11/16	1.52	.70	1.57	.79	.50	.210

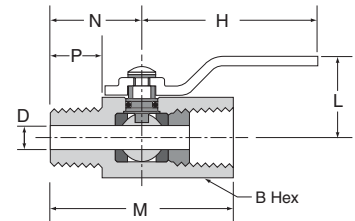

### Female Pipe Ends, Mini Ball Valve MV709

PART NO.	PIPE THREAD	B HEX	H	L	M	N	FLOW DIA. D
MV709-2	1/8	9/16	1.18	.63	1.52	.68	.180
MV709-4	1/4	11/16	1.52	.70	1.57	.76	.210

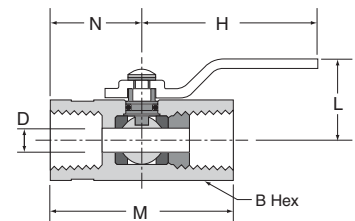



# Ball Valves

## Mini Series 200/608/609

### Product Features:

- Chrome Plated Brass Body
- Chrome Plated Brass Ball
- PTFE Seats/Seals
- Fluorocarbon Stem Seal
- 608/609 Polyamide Wedge Handle
- 200 Polyamide Lever Handle

### Style:

- MV-Mini Valve

### Type:

- 608-Male/Female
- 609-Female/Female
- 200-Female/Female
- 21-Oval Handle

### Specifications:

#### Pressure Range:

- MV200: 200 psi
- MV608/609: Vacuum Service 28 Inches Hg
- MV608/609: 450 psi

#### Temperature Range

- 0° to +200°F

MV200 Pressure and Temperature

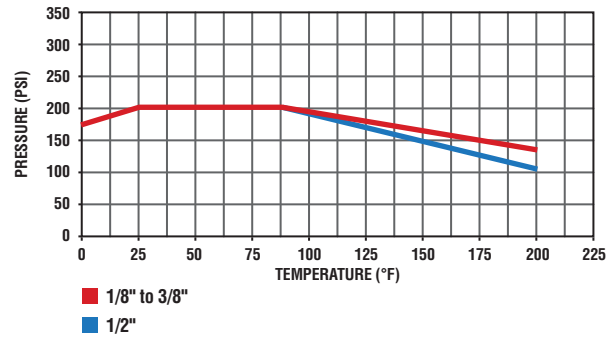

MV608/609 Pressure and Temperature

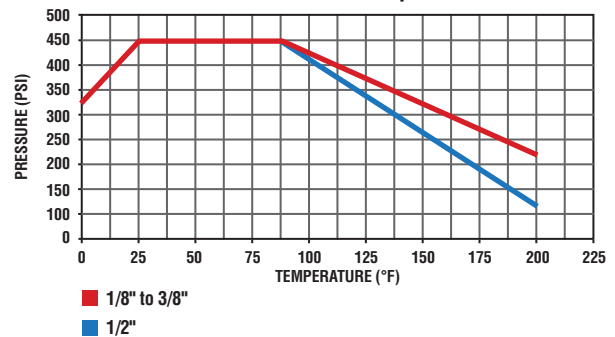

FLOW DATA			
VALVE SIZE	MV200 CV	MV608 CV	MV609 CV
1/8	1.3	1.2	1.4
1/4	4.0	5.8	4.3
3/8	3.7	3.9	3.6
1/2	5.8	5.6	6.0



### Female Pipe Ends, Lever Handle, Mini Ball Valve MV200

PART NO.	PIPE THREAD	HEX	B	C	H	L	FLOW DIA. D
MV200-2	1/8	.83	1.71	1.20	.91	2.83	.31
MV200-4	1/4	.83	1.71	1.20	.91	2.83	.31
MV200-6	3/8	.83	1.71	1.20	.91	2.83	.31
MV200-8	1/2	.98	2.11	1.28	1.10	2.83	.39

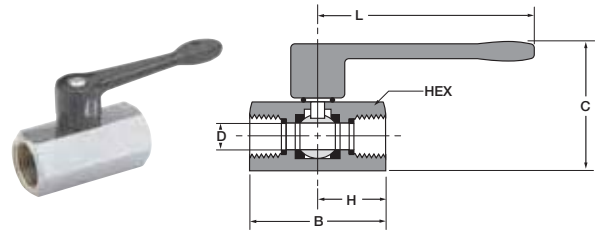

### Male-Female Pipe Ends, Compact Handle, Mini Ball Valve MV608

PART NO.	PIPE THREAD	A HEX	B	C	FLOW DIA. D
MV608-2	1/8	.83	1.72	1.22	.20
MV608-4	1/4	.83	1.72	1.22	.31
MV608-6	3/8	.83	1.72	1.22	.31
MV608-8	1/2	.98	2.11	1.30	.39

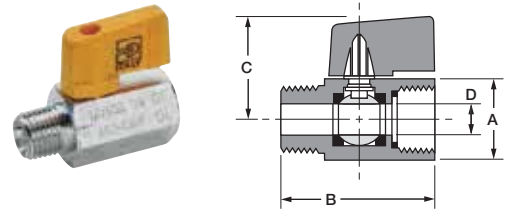

### Female Pipe Ends, Compact Handle, Mini Ball Valve MV609

PART NO.	PIPE THREAD	A HEX	B	C	FLOW DIA. D
MV609-2	1/8	.83	1.71	1.22	.24
MV609-4	1/4	.83	1.71	1.22	.31
MV609-6	3/8	.83	1.71	1.22	.31
MV609-8	1/2	.98	2.11	1.30	.39
MV609-6-4	3/8X1/4	.83	1.71	1.22	.31

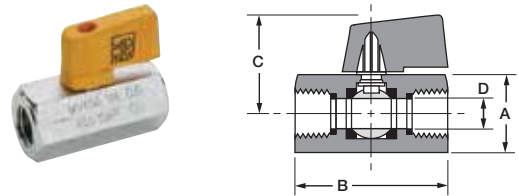



# Ball Valves

## Polypropylene

Parker's Polypropylene Ball Valves offers a corrosion-resistant, all plastic design making them ideal for water filtration units, coffee and beverage machines and a wide variety of other fluid applications.

### Product Features:

- Wide chemical acceptance range
- Bi-directional flow maximizes productivity
- Full flow reduces pressure drop across valve
- EPDM seals
- Push-in and barbed connections
- Meets FDA and NSF-51 requirements for food contact

### Advantages:

- Reduce costs – Built in LIQUIfit, TrueSeal and Par-Barb connections eliminates the need for a secondary fitting.
- Save Space – Low-profile design allows for easy assembly and access where space is at a premium.

### Type:

- LFPP – LIQUIfit
- PP – TrueSeal
- PBPP – Par-Barb

### Specifications:

#### Pressure Range:

- Up to 150 psi

#### Temperature Range

- LIQUIfit: 35° to +200°F
- Par-Barb: 35° to +200°F
- TrueSeal: 0° to +225°F

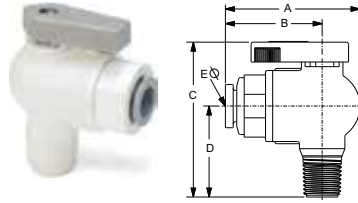

**VME - Valve Male Elbow**

PART NO.	NOM. TUBE O.D.	NPTF THREAD SIZE	A	B	C	D	ØE THRU HOLE MIN.
LFPP4VME2	1/4	1/8	1.74	1.21	2.00	1.10	.19
LFPP4VME4	1/4	1/4	1.74	1.21	2.18	1.28	.19
LFPP4VME6	1/4	3/8	1.74	1.21	2.18	1.28	.19
LFPP4VME8	1/4	1/2	1.74	1.21	2.37	1.47	.19
LFPP6VME2	3/8	1/8	1.85	1.32	2.00	1.10	.25
LFPP6VME4	3/8	1/4	1.85	1.32	2.18	1.28	.25
LFPP6VME6	3/8	3/8	1.85	1.32	2.18	1.28	.25
LFPP6VME8	3/8	1/2	1.85	1.32	2.37	1.47	.25

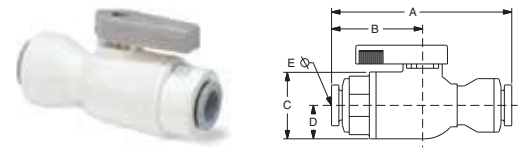

**VUC - Valve Union Connector Metric**

PART NO.	1 TUBE SIZE MM	2 TUBE SIZE MM	A MM	B MM	C MM	D MM	ØE THRU HOLE MIN. MM
LFPP6MVUC6M	6	6	.57	.27	.36	.13	.19
LFPP8MVUC8M	8	8	.60	.27	.36	.13	.25
LFPP10MVUC10M	10	10	.70	.33	.36	.13	.33
LFPP12MVUC12M	12	12	.88	.43	.36	.13	.37

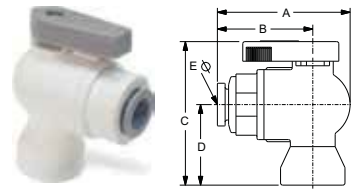

**VFE - Valve Female Elbow**

PART NO.	NOM. TUBE O.D.	NPTF THREAD SIZE	A	B	C	D	ØE THRU HOLE MIN.
LFPP4VFE2	1/4	1/8	1.74	1.21	1.82	.92	.19
LFPP4VFE4	1/4	1/4	1.74	1.21	2.05	1.15	.19
LFPP4VFE6	1/4	3/8	1.74	1.21	2.18	1.28	.19
LFPP6VFE2	3/8	1/8	1.85	1.32	1.82	.92	.25
LFPP6VFE4	3/8	1/4	1.85	1.32	2.05	1.15	.25
LFPP6VFE6	3/8	3/8	1.85	1.32	2.18	1.28	.25

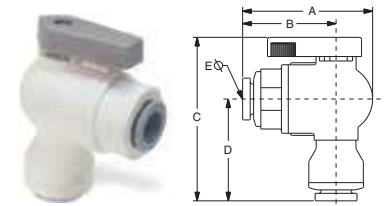

**VEU - Valve Elbow Union**

PART NO.	1 TUBE SIZE	2 TUBE SIZE	A	B	C	D	ØE THRU HOLE MIN.
LFPP4VEU4	1/4	1/4	1.75	1.22	2.33	1.42	.19
LFPP4VEU6	1/4	3/8	1.75	1.22	2.33	1.42	.11
LFPP6VEU4	3/8	1/4	1.83	1.30	2.32	1.40	.19
LFPP6VEU6	3/8	3/8	1.85	1.32	2.34	1.44	.25

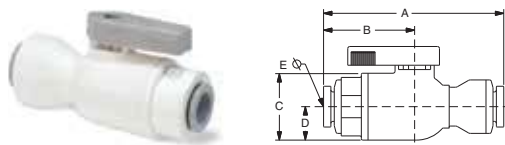

**VUC - Valve Union Connector**

PART NO.	1 TUBE SIZE	2 TUBE SIZE	A	B	C	D	ØE THRU HOLE MIN.
LFPP4VUC4	1/4	1/4	2.55	1.22	1.0	.5	.19
LFPP4VUC6	1/4	3/8	2.57	1.30	1.0	.5	.19
LFPP6VUC6	3/8	3/8	2.67	1.32	1.4	.5	.25

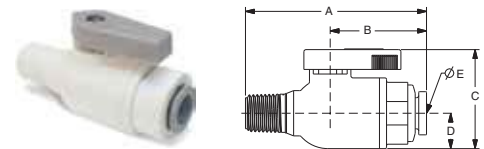

**VMC - Valve Male Connector**

PART NO.	NOM. TUBE O.D.	NPTF THREAD SIZE	A	B	C	D	ØE THRU HOLE MIN.
LFPP4VMC2	1/4	1/8	2.22	1.21	1.4	.5	.19
LFPP4VMC4	1/4	1/4	2.40	1.21	1.4	.5	.19
LFPP4VMC6	1/4	3/8	2.40	1.21	1.4	.5	.19
LFPP4VMC8	1/4	1/2	2.59	1.21	1.4	.5	.19
LFPP6VMC2	3/8	1/8	2.33	1.32	1.4	.5	.25
LFPP6VMC4	3/8	1/4	2.51	1.32	1.4	.5	.25
LFPP6VMC6	3/8	3/8	2.51	1.32	1.4	.5	.25
LFPP6VMC8	3/8	1/2	2.70	1.32	1.4	.5	.25

NOTE: PPL refers to Polypropylene. FCB refers to Fluorocarbon.



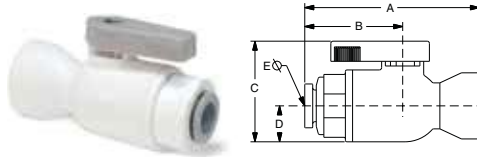

**VFC - Valve Female Connector**

PART NO.	NOM. TUBE O.D.	NPTF THREAD SIZE	A	B	C	D	ØE THRU HOLE MIN.
LFPP4VFC2	1/4	1/8	2.04	1.21	1.4	.5	.19
LFPP4VFC4	1/4	1/4	2.27	1.21	1.4	.5	.19
LFPP4VFC6	1/4	3/8	2.40	1.21	1.4	.5	.19
LFPP6VFC2	3/8	1/8	2.15	1.32	1.4	.5	.25
LFPP6VFC4	3/8	1/4	2.38	1.32	1.4	.5	.25
LFPP6VFC6	3/8	3/8	2.51	1.32	1.4	.5	.25

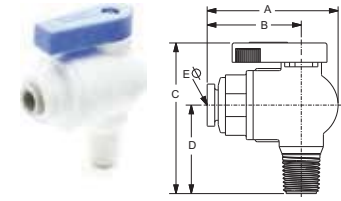

**VME - Valve Male Elbow**

PART NUMBER	NOM. TUBE O.D.	NPTF THREAD SIZE	A	B	C	D	ØE THRU HOLE MIN.
PP4VME2-MG (+)	1/4	1/8	1.74	1.21	2.00	1.10	.19
PP4VME4-MG	1/4	1/4	1.74	1.21	2.18	1.28	.19
PP4VME6-MG	1/4	3/8	1.74	1.21	2.18	1.28	.19
PP4VME8-MG (+)	1/4	1/2	1.74	1.21	2.37	1.47	.19
PP6VME2-MG (+)	3/8	1/8	1.85	1.32	2.00	1.10	.25
PP6VME4-MG	3/8	1/4	1.85	1.32	2.18	1.28	.25
PP6VME6-MG	3/8	3/8	1.85	1.32	2.18	1.28	.25
PP6VME8-MG	3/8	1/2	1.85	1.32	2.37	1.47	.25

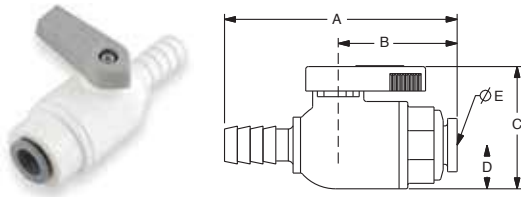

**VUCPB - Valve Union Connector Barbed x Tube**

PART NO.	HOSE ID	TUBE OD	OD	A	B	C	D	ØE THRU HOLE MIN.
LFPP4VUCPB4	1/4	1/4	.31	2.40	1.08	1.42	.50	.15
LFPP6VUCPB6	3/8	3/8	.43	2.63	1.32	1.42	.50	.19

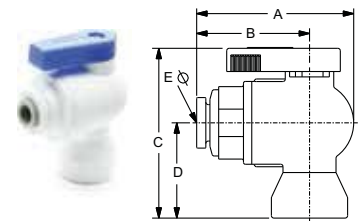

**VFE - Valve Female Elbow**

PART NUMBER	NOM. TUBE O.D.	NPTF THREAD SIZE	A	B	C	D	ØE THRU HOLE MIN.
PP4VFE2-MG (+)	1/4	1/8	1.74	1.21	1.82	.92	.19
PP4VFE4-MG	1/4	1/4	1.74	1.21	2.05	1.15	.19
PP4VFE6-MG	1/4	3/8	1.74	1.21	2.18	1.28	.19
PP6VFE2-MG (+)	3/8	1/8	1.85	1.32	1.82	.92	.25
PP6VFE4-MG	3/8	1/4	1.85	1.32	2.05	1.15	.25
PP6VFE6-MG	3/8	3/8	1.85	1.32	2.18	1.28	.25

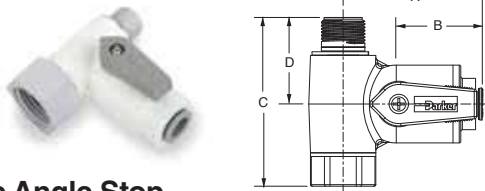

**VAS - Valve Angle Stop**

PART NO.	TUBE O.D.	MALE THD.	FEMALE THD.	A	B	C	D	E	F
LFPP4VAS6	1/4	3/8	3/8	1.95	1.24	2.17	1.11	1.41	.91
LFPP4VAS8	1/4	3/8	1/2	1.95	1.24	2.40	1.11	1.41	.91
LFPP6VAS6	3/8	3/8	3/8	2.06	1.35	2.17	1.11	1.41	.91
LFPP6VAS8	3/8	3/8	1/2	2.06	1.35	2.40	1.11	1.41	.91

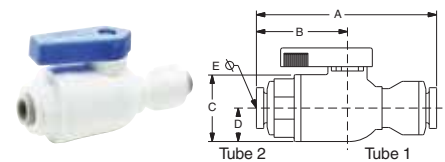

**VUC - Valve Union Connector**

PART NUMBER	1 TUBE SIZE	2 TUBE SIZE	A	B	C	D	ØE THRU HOLE MIN.
PP4VUC4-MG	1/4	1/4	2.55	1.22	1.0	.5	.19
PP4VUC6-MG	1/4	3/8	2.55	1.22	1.0	.5	.19
PP6VUC4-MG	3/8	1/4	2.57	1.30	1.0	.5	.19
PP6VUC6-MG	3/8	3/8	2.67	1.32	1.4	.5	.25

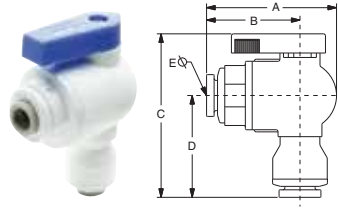

**VEU - Valve Elbow Union**

PART NUMBER	1 TUBE SIZE	2 TUBE SIZE	A	B	C	D	ØE THRU HOLE MIN.
PP4VEU4-MG	1/4	1/4	1.75	1.22	2.33	1.42	.19
PP4VEU6-MG	1/4	3/8	1.75	1.22	2.33	1.42	.11
PP6VEU4-MG	3/8	1/4	1.83	1.30	2.32	1.40	.19
PP6VEU6-MG	3/8	3/8	1.85	1.32	2.34	1.44	.25

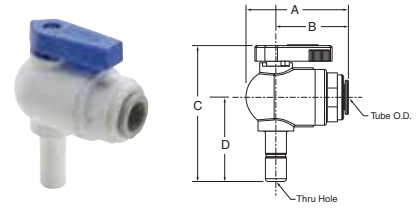

**VTEU - Valve Tube Elbow Union**

PART NUMBER	NOM. TUBE O.D.	STEM	A	B	C	D	ØE THRU HOLE MIN.
PP4VTEU6-MG	1/4	3/8	1.75	1.22	2.43	1.50	.17
PP6VTEU6-MG	3/8	3/8	1.83	1.30	2.43	1.50	.25

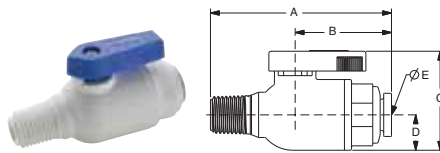

**VMC - Valve Male Connector**

PART NUMBER	NOM. TUBE O.D.	NPTF THREAD SIZE	A	B	C	D	ØE THRU HOLE MIN.
PP4VMC2-MG (+)	1/4	1/8	2.22	1.21	1.4	.5	.19
PP4VMC4-MG	1/4	1/4	2.40	1.21	1.4	.5	.19
PP4VMC6-MG	1/4	3/8	2.40	1.21	1.4	.5	.19
PP4VMC8-MG (+)	1/4	1/2	2.59	1.21	1.4	.5	.19
PP6VMC2-MG (+)	3/8	1/8	2.33	1.32	1.4	.5	.25
PP6VMC4-MG	3/8	1/4	2.51	1.32	1.4	.5	.25
PP6VMC6-MG	3/8	3/8	2.51	1.32	1.4	.5	.25
PP6VMC8-MG (+)	3/8	1/2	2.70	1.32	1.4	.5	.25

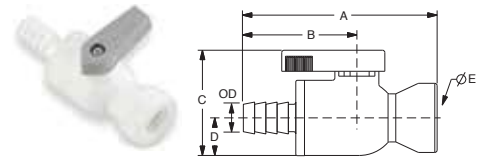

**VFC - Valve Barbed Female Connector**

PART NO.	HOSE I.D.	NPTF THD.	O.D.	A	B	C	D	ØE THRU HOLE MIN.
PBPP4VFC4	1/4	1/4	.31	2.76	1.60	1.41	.50	.15
PBPP6VFC6	3/8	3/8	.43	2.79	1.60	1.41	.50	.19

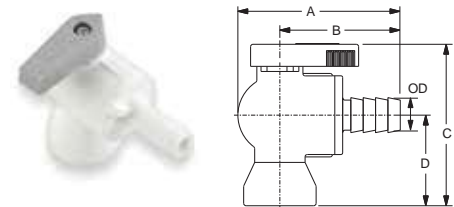

**VFE - Valve Barbed Female Elbow**

PART NO.	HOSE I.D.	NPTF THD.	O.D.	A	B	C	D	ØE THRU HOLE MIN.
PBPP4VFE4	1/4	1/4	.31	2.13	1.60	2.05	1.15	.15
PBPP6VFE4	3/8	1/4	.43	2.13	1.60	2.05	1.15	.15
PBPP6VFE6	3/8	3/8	.43	2.13	1.60	2.18	1.28	.19

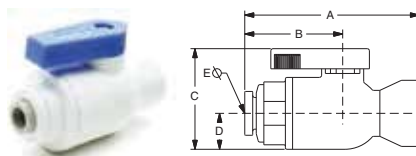

**VFC - Valve Female Connector**

PART NUMBER	NOM. TUBE O.D.	NPTF THREAD SIZE	A	B	C	D	ØE THRU HOLE MIN.
PP4VFC2-MG	1/4	1/8	2.04	1.21	1.4	.5	.19
PP4VFC4-MG	1/4	1/4	2.27	1.21	1.4	.5	.19
PP4VFC6-MG	1/4	3/8	2.40	1.21	1.4	.5	.19
PP6VFC2-MG	3/8	1/8	2.15	1.32	1.4	.5	.25
PP6VFC4-MG	3/8	1/4	2.38	1.32	1.4	.5	.25
PP6VFC6-MG	3/8	3/8	2.51	1.32	1.4	.5	.25

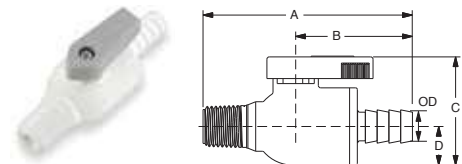

**VMC - Valve Barbed Male Connector**

PART NO.	HOSE I.D.	NPTF THD.	O.D.	A	B	C	D	ØE THRU HOLE MIN.
PBPP4VMC4	1/4	1/4	.31	2.79	1.60	1.42	.50	.15
PBPP6VMC6	3/8	3/8	.43	2.79	1.60	1.42	.50	.19

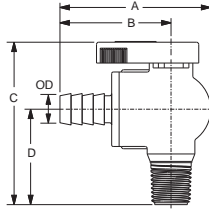

**VME - Valve Barbed Male Elbow**

PART NO.	HOSE I.D.	NPTF THD.	O.D.	A	B	C	D	ØE THRU HOLE MIN.
PBPP4VME4	1/4	1/4	.31	2.13	1.60	2.18	1.28	.15
PBPP6VME6	3/8	3/8	.43	2.13	1.60	2.18	1.28	.19

**BVC Ball Valve Clip**

BV-Clip Shown below holding VUCPB and VME

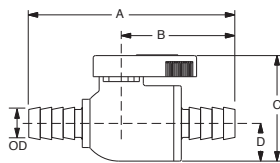
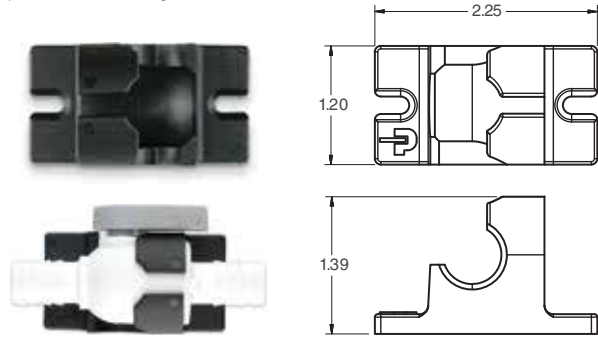

**VUC - Valve Barbed Union Connector**

PART NO.	HOSE I.D.	O.D.	A	B	C	D	ØE THRU HOLE MIN.
PBPP4VUC4	1/4	.31	2.91	1.60	1.42	.50	.15
PBPP6VUC6	3/8	.43	2.91	1.60	1.42	.50	.19
PBPP8VUC8	1/2	.55	2.91	1.60	1.42	.50	.25

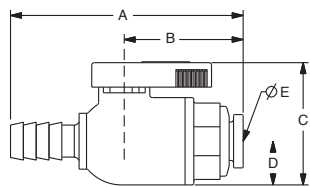

**VUCPB - Valve Union Connector Barbed x Tube**

PART NO.	HOSE ID	TUBE OD	OD	A	B	C	D	ØE THRU HOLE MIN.
LFPP4VUCPB4	1/4	1/4	.31	2.40	1.08	1.42	.50	.15
LFPP6VUCPB6	3/8	3/8	.43	2.63	1.32	1.42	.50	.19



# Plug Valves Series PV

## Product Features:

- Extruded Brass Body
- One Piece Stem/Handle
- Acetal Stem/Handle
- 100% Leak Tested

## Style:

- PV-Plug Valve

## Type:

- 607-Male/Male
- 608-Male/Female
- 609-Female/Female

## Specifications:

### Pressure Range:

- Up to 250 psi

### Temperature Range

- -40° to +175°F

## Valve Components

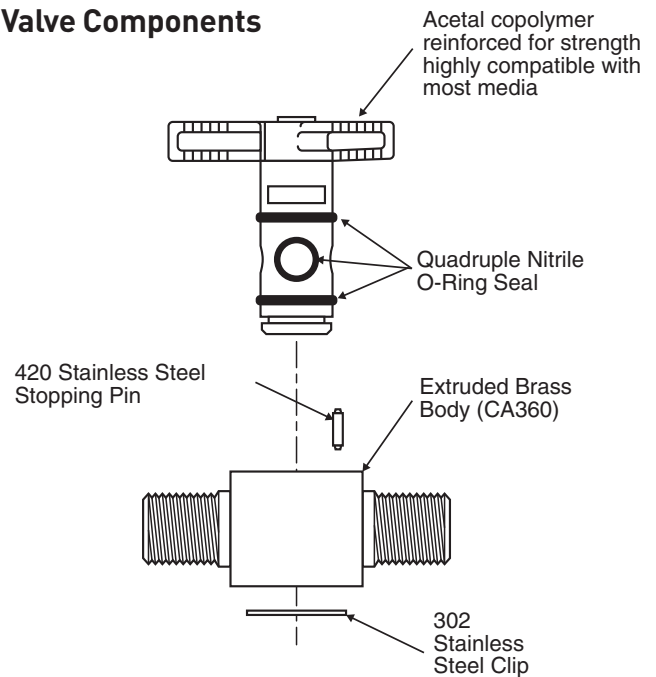

### Male Pipe to Male Pipe Plug Valve PV607

PART NO.	PIPE THREAD	H	L	M	N	N1	FLOW DIA. D
PV607-2	1/8	.67	1.34	1.66	1.38	.51	.200
PV607-4	1/4	.67	1.34	2.02	1.38	.51	.200

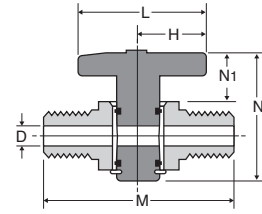

### Female Pipe to Male Pipe Plug Valve PV608

PART NO.	PIPE THREAD	H	L	M	N	N1	FLOW DIA. D
PV608-2	1/8	.67	1.34	1.67	1.38	.51	.200
PV608-4	1/4	.67	1.34	2.06	1.38	.51	.200

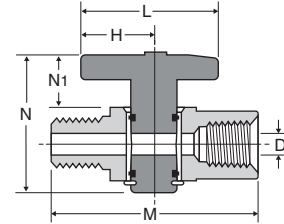

### Female Pipe to Female Pipe Plug Valve PV609

PART NO.	PIPE THREAD	H	L	M	N	N1	FLOW DIA. D
PV609-2	1/8	.67	1.34	1.68	1.38	.51	.200
PV609-4	1/4	.67	1.34	2.10	1.38	.51	.200

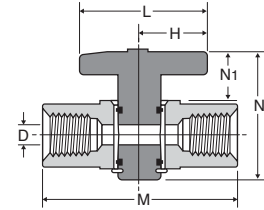

### Mounting Bracket PVMB-001

PART NO.	H	M	N	N1	D
PVMB-001	.68	1.86	.90	.45	.135

Note: 1" diameter hole required in panel when using mounting bracket

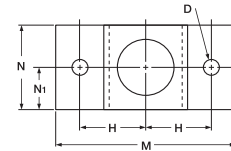



# Ball Valves

## Rotary Actuator Series ACT



### Product Features:

- One Piece Aluminum Extrusion Body
- PTFE Seals
- Stainless Steel Shaft
- Self Lubricated Vane Seal
- Anodized Aluminum Extrusion Vane

### Specifications:

#### Pressure Range:

- 150 psi Maximum Air Pressure to Actuator
- Vacuum service 28 inches Hg

#### Temperature Range

- -40° to +180°F

### How Do Vane Actuators Work?

Parker vane actuators provide the maximum amount of output torque from the smallest possible envelope size. They convert fluid power pressure into rotary motion for a wide variety of industrial applications. Double vane units produce twice the torque output of single vane actuators from identical envelope dimensions and have a maximum rotation of 95°.

A short cylindrical chamber encloses a vane attached to a central shaft. Fluid pressure differential is applied through a stationary barrier (stator) within the cylinder to one side of the vane. The opposite side of the vane is connected to exhaust through the stator. This pressure differential produces rotation of the vane and central shaft. Due to vane actuator design there will always be some internal bypass in these units.

### Rotary Actuator Series ACT Features

(See figure 1, next page)

1. **Heads**-are precision machined from aluminum, then hard-coat anodized and PTFE impregnated to ensure long seal life and low breakaway pressure.
2. **Body** - is machined from a one-piece aluminum extrusion that incorporates the stator for superior rigidity. The extrusion is hard-coat anodized and PTFE impregnated, resulting in a smooth, slick seal surface which guarantees long seal life and low breakaway pressure.
3. **Shoulder Seal** - a nitrile-energized, PTFE seal is used to reduce bypass flow and friction, providing superior performance and long life.
4. **Shaft Seal** - the high-quality, self-lubricated, abrasion-resistant nitrile seal is a multiple lobe construction for leakfree operation and greater reliability.
5. **Shaft** - stainless steel provides high strength and corrosion resistance for the most demanding applications.
6. **Bearings** - hard-coat anodized aluminum-bearing surface with permanent solid film lubricant provides substantial shaft support and wear resistance, ensuring continuous lubrication, high performance, and long life.
7. **Mounting** - combination face and base mounting offer flexibility in application and design.
8. **Vane Seal** - a special self-lubricated, abrasion-resistant nitrile compound is molded into a one-piece vane seal, providing low breakaway pressure and long life, even with no lubrication. The vane seal is also removable so that field repairs can be made, if necessary.
9. **Vane** - a hard-coat anodized aluminum extrusion permanently affixed to shaft, forming a structurally sound assembly. The light weight also reduces inertia allowing faster operating speeds.

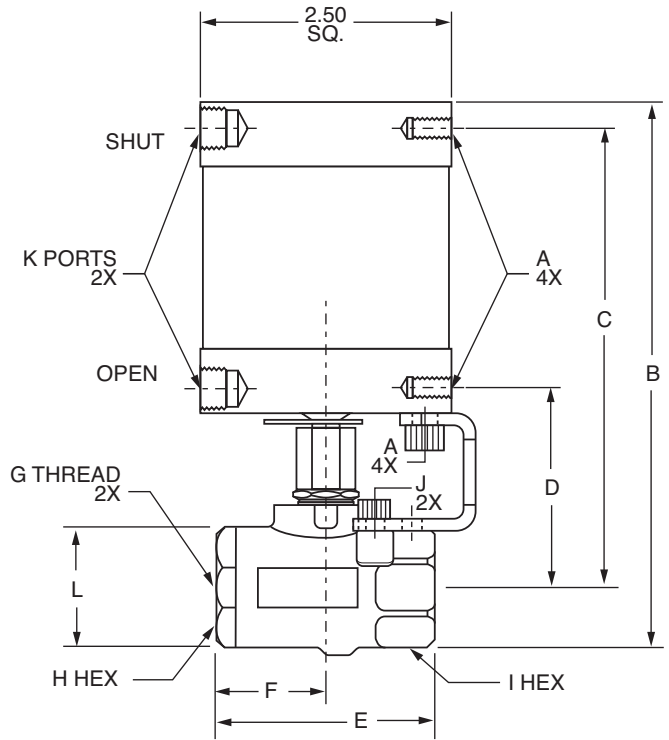
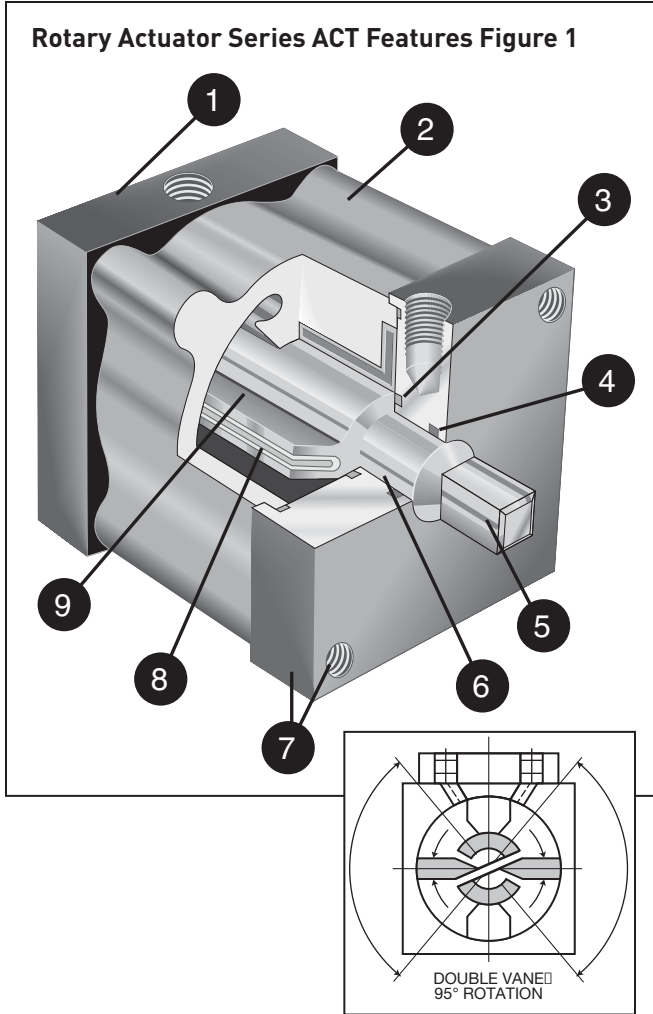

**Rotary Actuator, Female Pipe Ends V502P-X-ACT**

PART NO.	SIZE	A MTG. HOLES	B	C	D	E	F	G	H HEX	I HEX	J UNC	K NPTF	L	FLOW DIA.	FLOW CV	MIN. ACT PRESSURE (PSI)
V502P-4-ACT	1/4	1/4-20 UNC	5.25	4.47	1.91	2.03	1.00	1/4-18PTF	15/16	15/16	10-24	1/8-27	1.06	.375	4.0	50
V502P-6-ACT	3/8	1/4-20 UNC	5.25	4.47	1.91	2.03	1.00	3/8-18PTF	15/16	15/16	10-24	1/8-27	1.06	.375	5.8	50
V502P-8-ACT	1/2	1/4-20 UNC	5.38	4.54	1.98	2.20	1.09	1/2-14PTF*	1-1/16	1-1/16	10-24	1/8-27	1.19	.500	12.0	50
V502P-12-ACT	3/4	1/4-20 UNC	5.57	4.63	2.07	2.42	1.29	3/4-14PTF**	1-5/16	1-1/4	10-24	1/8-27	1.38	.685	25.0	75
V502P-16-ACT	1	1/4-20 UNC	5.85	4.76	2.20	2.75	1.38	1-11.5PTF**	1-9/16	1-1/2	10-24	1/8-27	1.67	.875	35.0	75

**Stainless Steel Rotary Actuator, Female Pipe Ends V502SS-X-ACT**

PART NO.	SIZE	A MTG. HOLES	B	C	D	E	F	G	H/I HEX	J	K NPTF	L	FLOW DIA.	FLOW CV
V502SS-4-ACT	1/4	1/4-20 UNC	5.41	4.61	2.05	2.07	1.04	1/4-18 NPT	15/16	10-24	1/8-27	1.10	.375	4.0
V502SS-6-ACT	3/8	1/4-20 UNC	5.41	4.61	2.05	2.07	1.04	3/8-18 NPT	15/16	10-24	1/8-27	1.10	.375	6.0
V502SS-8-ACT	1/2	1/4-20 UNC	5.53	4.64	2.08	2.27	1.17	1/2-14 NPT	1 1/16	10-24	1/8-27	1.28	.500	14.0

\*Ptf Special Short. \*\*Ptf Special Extra Short

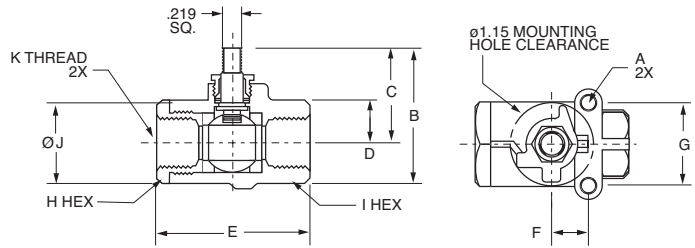

**Actuator Sub-Assembly V502P-X-SUB**

PART NO	SIZE	A UNC	B	C	D	E	F	G	H HEX	I HEX	J	K
V502P-4-SUB	1/4	10-24	1.68	1.15	.495	2.03	.50	1.12	15/16	15/16	1.06	1/4-18 PTF
V502P-6-SUB	3/8	10-24	1.68	1.15	.495	2.03	.50	1.12	15/16	15/16	1.06	3/8-18 PTF
V502P-8-SUB	1/2	10-24	1.78	1.19	.565	2.20	.50	1.12	1-1/16	1-1/16	1.19	1/2-14 PTF*
V502P-12-SUB	3/4	10-24	2.09	1.40	.655	2.42	.87	1.37	1-5/16	1-1/4	1.38	3/4-14 PTF**
V502P-16-SUB	1	10-24	2.38	1.54	.785	2.75	.87	1.37	1-9/16	1-1/2	1.67	1-11.5 PTF**

\* PTF Special Short  
 \*\* PTF Special Extra Short

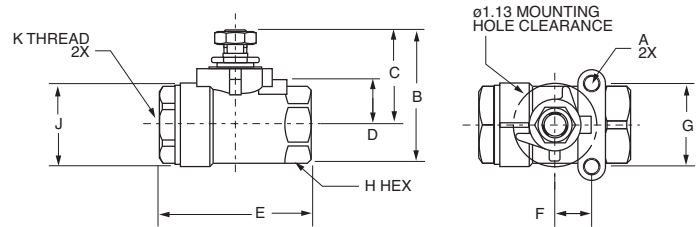

**Actuator Sub-Assembly V502SS-X-SUB**

PART NO	SIZE	A UNC	B	C	D	E	F	G	H HEX	J	K
V502SS-4-SUB	1/4	10-24	1.88	1.32	.63	2.07	.50	1.12	15/16	1.10	1/4-18 NPT
V502SS-6-SUB	3/8	10-24	1.88	1.32	.63	2.07	.50	1.12	15/16	1.10	3/8-18 NPT
V502SS-8-SUB	1/2	10-24	2.00	1.35	.66	2.27	.50	1.12	1-1/16	1.28	1/2-14 NPT

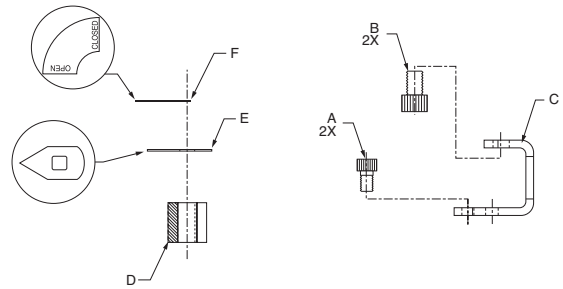

**ACT-P-X-KIT**

PART NO.	FOR USE WITH	A	B	C	D	E	F
ACT-P-1-KIT	V502P-4, 6, 8-ACT	10-24 UNC	1/4-20 UNC	BRACKET	.60 LONG COUPLING	POSITION INDICATOR	POSITION LABEL
ACT-P-2-KIT	V502P-12, 16-ACT	10-24 UNC	1/4-20 UNC	BRACKET	.55 LONG COUPLING	POSITION INDICATOR	POSITION LABEL

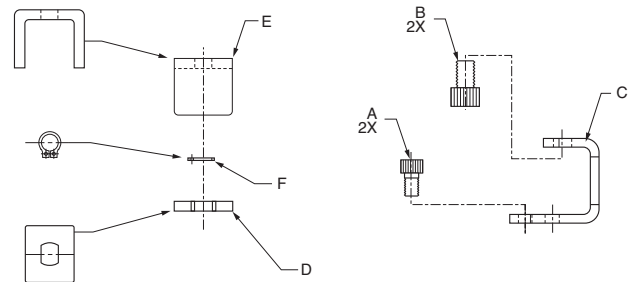

**ACT-SS-X-KIT**

PART NO.	FOR USE WITH	A	B	C	D	E	F
ACT-SS-1-KIT	V502SS-4, 6, 8-ACT	10-24 UNC	1/4-20 UNC	BRACKET	CLIP	HANDLE YOKE	SNAP RING

# Ball Valve Series BVGC



## Product Features:

- Nickel plated brass body
- Chrome plated brass ball
- PTFE seats/seals
- PTFE packing gland

## Specifications:

- Female BSPP short threads manufactured
- in accordance to ISO 228 / DIN 259

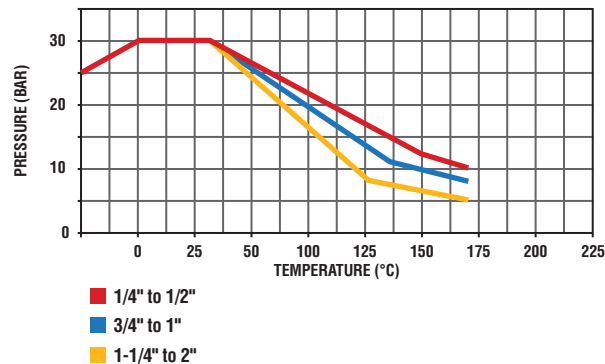

## Advantages

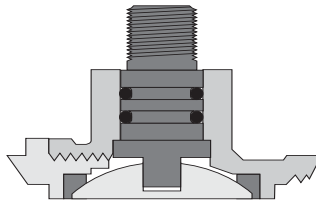

### Anti extrusion stem

The BVGC series ball valves are fitted with an anti-extrusion stem to prevent blow out in the case of pressure peaks.

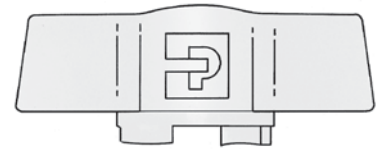

### Compact handle

For applications where space is at a premium, the BVGC series valve is available with a compact handle in sizes up to 1".

### BVGC BSPP Female/Female Valve With Lever Handle

PART NO.	DN MM	THREAD BSPP	C	H	L	L1	O
BVG4-1/4C	8	1/4	20	39.5	39	82	25.0
BVG4-3/8C	10	3/8	20	39.5	39	82	25.0
BVG4-1/2C	15	1/2	25	44.0	50	100	32.5
BVG4-3/4C	20	3/4	31	50.0	54	120	39.0
BVG4-1C	25	1	38	54.0	67	120	47.5
BVG4-1.1/4C	32	1.1/4	48	76.5	77	158	59.0
BVG4-2C	50	2	66	89.5	106	158	86.0

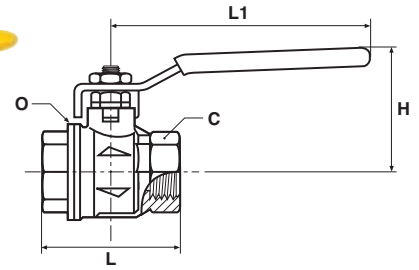

### BVGT4 BSPP Female/Female Valve with Compact Handle

PART NO.	DN MM	THREAD BSPP	C	H	L	L1	O
BVGT4-1/4C	8	1/4	20	40	39	50	25.0
BVGT4-3/8C	10	3/8	20	40	39	50	25.0
BVGT4-3/4C	20	3/4	31	49	54	60	39.0

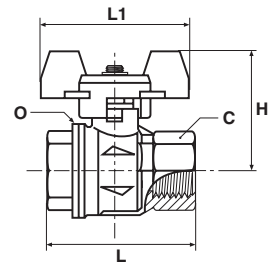

# Ball Valve Series BVGL



## Product Features:

- Nickel plated brass body
- Chrome plated brass ball
- PTFE seats/seals
- Fluorocarbon stem seal

## Specifications:

- Female threads manufactured in accordance to DIN 2999/ISO 228

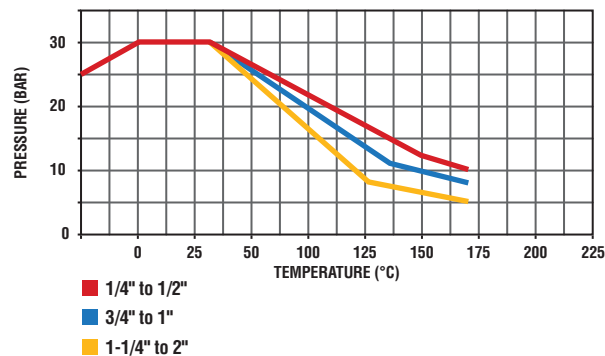

## Advantages

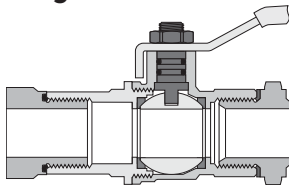

### Long female threads

BVGL series valves are manufactured with long female threads in accordance to DIN 2999/ISO 228. This enables the valves to be used with Prestolok and brass adaptors but also Parker's range of steel hydraulic fittings, e.g. Triple-Lok, O-Lok, EO, and BSPP coned adaptors.

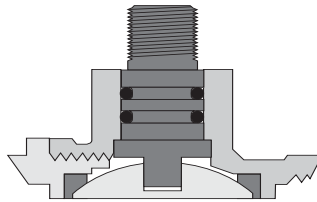

### Anti extrusion stem

The BVGL series ball valves are fitted with an anti extrusion stem to prevent blow out in the case of pressure peaks. The stem is sealed with two Fluorocarbon O-rings for maximum safety and performance.

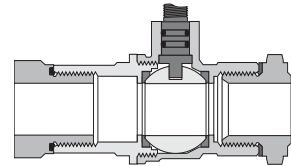

### Full flow

All BVGL series valves are full-flow. This limits the turbulence created by the passage of fluid across the valve, minimizing pressure drop.

### BVGL BSPP Female/Female Valve with Lever Handle

PART NO.	DN MM	THREAD BSPP	C	H	L	L1	O
BVG4-1/4L	8	1/4	20	38	50	82	25.0
BVG4-3/8L	10	3/8	20	38	60	82	25.0
BVG4-1/2L	15	1/2	25	43	75	100	32.5
BVG4-3/4L	20	3/4	32	50	80	120	39.0
BVG4-1L	25	1	41	54	90	120	47.5
BVG4-1.1/4L	32	1 1/4	50	73	110	158	59.0
BVG4-1.1/2L	40	1 1/2	55	79	120	158	71.5
BVG4-2L	50	2	70	86	140	158	86.0

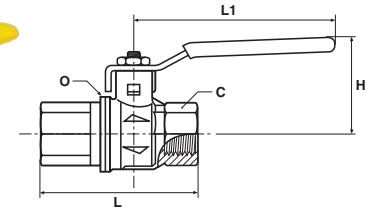

### BVGT4 BSPP Female/Female Valve with Compact Handle

PART NO.	DN MM	THREAD BSPP	C	H	L	L1	O
BVGT4-1/4L	8	1/4	20	39	50	50	25.0
BVGT4-3/8L	10	3/8	20	39	60	50	25.0
BVGT4-1/2L	15	1/2	25	43	75	50	32.5
BVGT4-3/4L	20	3/4	32	47	80	60	39.0
BVGT4-1L	25	1	41	51	90	60	47.5

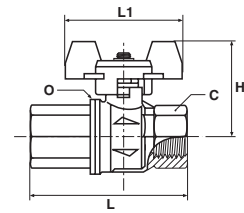

# Ball Valve Series BVGLOCK



## Product Features:

- Nickel plated brass body
- Chrome plated brass ball
- PTFE seats /seals
- PTFE packing gland
- Carbon steel handle

## Specifications:

- Meets the requirements of European directive DI 89/392/ CEE relating to the isolation of power supply and to meet the health and safety requirements for machines and materials in paragraphs L233-5 of the code DU Travail.

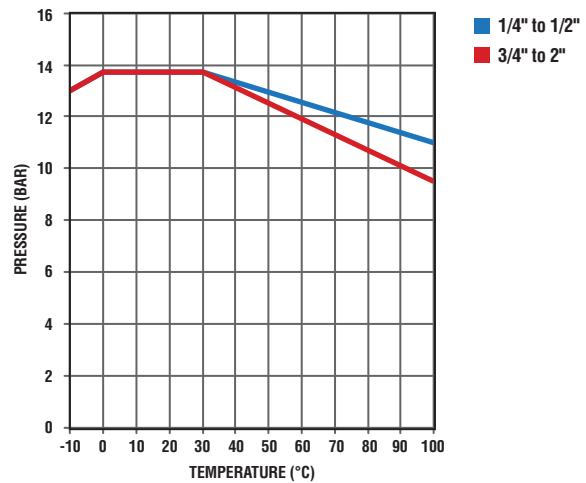



## Advantages

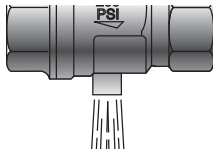

### Threaded Exhaust

BVGPLOCK series ball valves are manufactured with an exhaust port, this safety feature enables the downstream air pressure to be vented when the valve is closed. 1/4-1" have M5 thread. 1.1/4 and larger are not threaded.

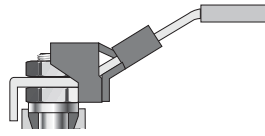

### Lockable Handle

The BVGPLOCK series ball valves are fitted with a handle that can be locked in the closed position with a padlock. This safety feature ensures the valve cannot be accidentally opened, and only authorized personnel can operate the valve.

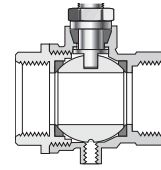

### DIN 2999 / ISO 228 Female Threads

BVGPLOCK series valves are manufactured with long female threads in accordance to DIN2999/ISO228. This enables the valves to be used with Prestolok and brass adaptors but also Parker's range of steel hydraulic fittings and EO-fittings form "A" or "C" to DIN 3852.

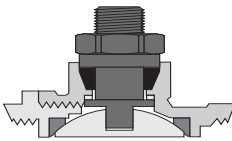

### Anti Extrusion Stem

The BVGPLOCK series ball valves are fitted with an anti-extrusion stem to prevent blow out in the case of pressure peaks.

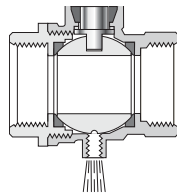

### Full Flow

All BVGPLOCK series valves are full-flow. This limits the turbulence created by the passage of fluid across the valve, minimizing pressure drop.

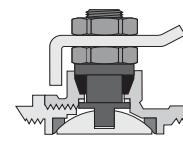

### Adjustable Packing

The PTFE packing gland and adjustable washer are designed to give longer service life and lower operating torques.

## BVG4PLOCK BSPP Female/Female, Vented, Locking Handle

PART NO.	D FLOW Ø	THREAD BSPP	C	G	H	I	L	L1	N
BVG4P-1/4 LOCK	8.0	1/4	20	22.5	47.5	12.0	45	96	M5
BVG4P-3/8 LOCK	9.5	3/8	20	22.5	47.5	12.0	45	96	
BVG4P-1/2 LOCK	15.0	1/2	25	29.5	52.0	15.5	59	96	
BVG4P-3/4 LOCK	19.0	3/4	31	32.0	59.5	17.0	64	117	
BVG4P-1 LOCK	24.0	1	40	40.5	63.5	21.0	81	117	
BVG4P-1.1/4LOCK	32.0	1-1/4	49	46.5	76.5	23.0	93	158	G1/4
BVG4P-1.1/2LOCK	40.0	1-1/2	54	51.0	82.5	23.0	102	158	
BVG4P-2LOCK	50.0	2	69	60.5	89.5	26.5	121	158	

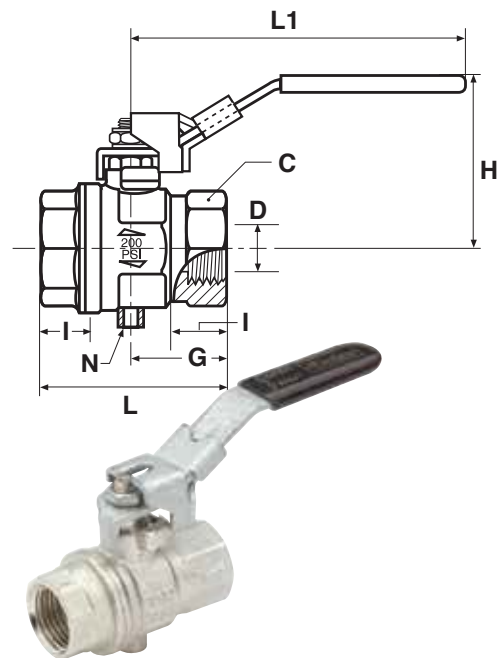

# Ball Valve Series MBVG



## Product Features:

- Chrome plated brass body
- Chrome plated brass ball
- PTFE seats/seals
- Fluorocarbon stem seal
- Polyamide handle

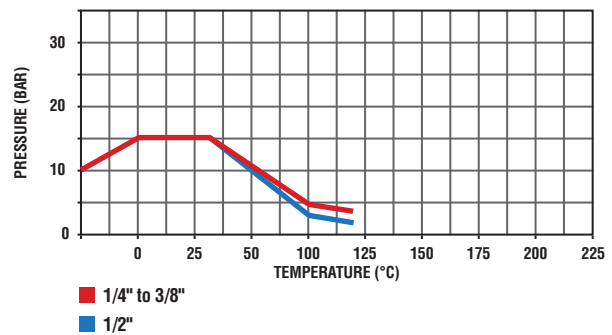

## Advantages

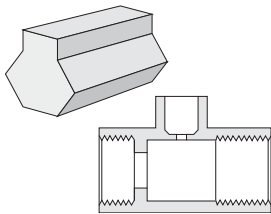

### Design of the body

The valve is manufactured from a solid section which incorporates the stem housing in the body. This design allows excellent guidance of the stem, which increases its lifespan.

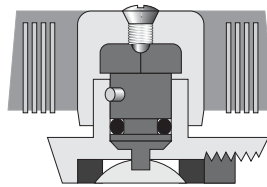

### Stem tightness

A Fluorocarbon O-Ring assembled under compression automatically compensates for minute friction wear. Thus a high standard of seal is attained.

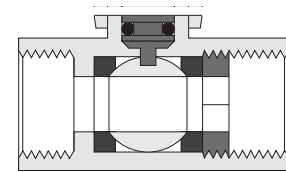

### Tightness of the seals

The perfect tightness of the seals on the casing is obtained by the preset force of the nut, adjusted during assembly.

### MBVG BSPP Female/Female Valve

PART NO.	DN MM	THREAD BSPP	C	H	L	L1
MBVG4-1/4	8	1/4	21	31.5	41.5	39
MBVG4-3/8	8	3/8	21	31.5	41.5	39
MBVG4-1/2	10	1/2	25	33.5	48.0	39

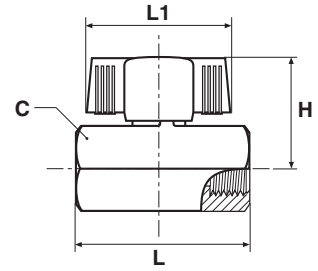

# Axial Valves



Parker's Axial Valve incorporates both the valve and actuation function. With pneumatic or electro-pneumatic control, it avoids many of the restrictions associated with traditional actuators.

## Product Features:

- Compact, up to 50% smaller than valves with separate actuators
- Simple to install
- Common sub-base for solenoid control
- Automation of the open/close function
- Operation independent of the upstream and downstream pressure in the circuit

## Specifications:

### Pressure Range:

- Up to 150 psi

### Vacuum Service:

- 29 in Hg

### Pilot Pressure:

- NC: 60 to 115 psi

### Temperature Range:

- $-4^{\circ}$  to  $+275^{\circ}$ F

## Water at ambient temperature under a 1 bar differential pressure.

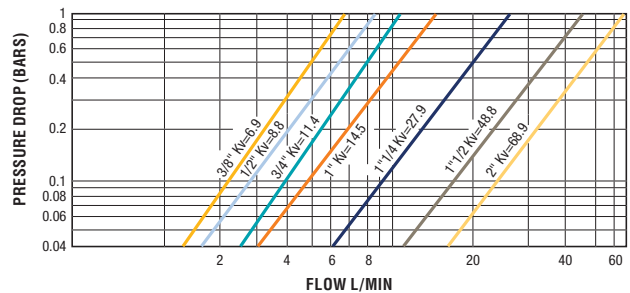

## Applications:

- Injection Molding
- Pneumatics
- Packaging
- Textile
- Printing
- Robotics

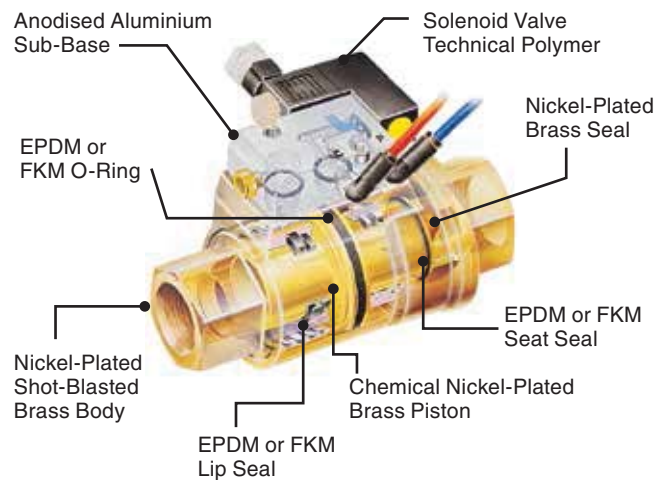

## Operation

Depending on operational requirement, air is passed into the actuation chamber to open or close the valve.

### Normally Closed Axial Valve (NC)

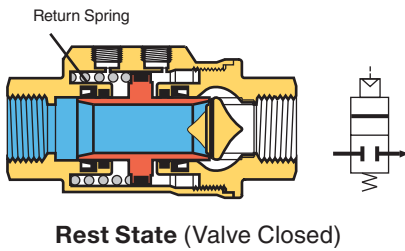

### Normally Open Axial Valve (NO)

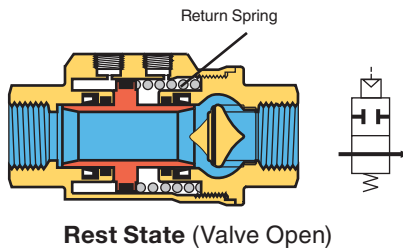

### Double-Acting Axial Valve (DE)

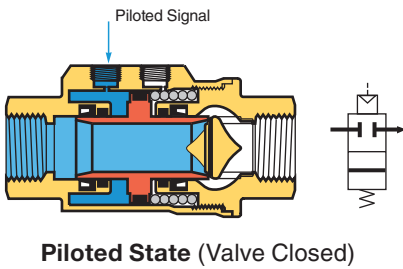
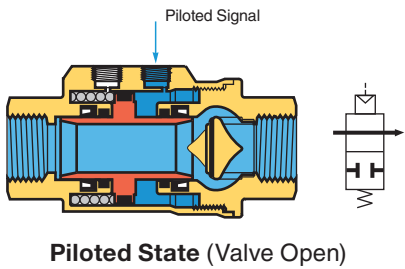
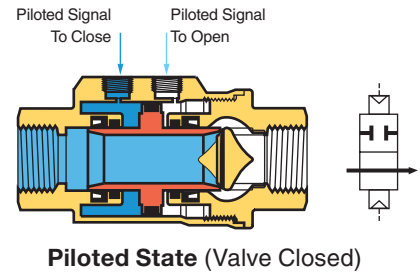

## Installation Options

The Parker axial valve offers 3 different control methods dependant on the requirements of the installation:

### Pneumatic Control

**Example:** Double-acting axial valve 4222

- Local compressed air control
- For repetitive on/off cycles
- Remote control where access to the machine is difficult
- For explosive or explosion prevention areas

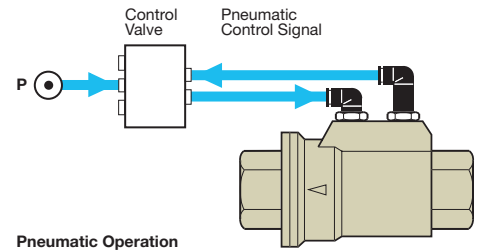

### Electro-Pneumatic Control

**Example:** Normally closed axial valve 4202

- Sub-base and mini-solenoid valve 4298
- For automated industrial systems requiring remote control
- Namur seating plane solenoid valve

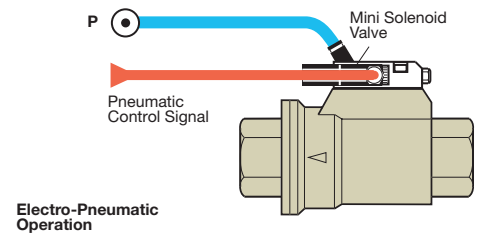

### Dual Pneumatic and Electro-Pneumatic Control

**Example:** Normally open axial valve 4212

- Sub-base and mini-solenoid valve 4298
- Pneumatic push-button 4299
- Dual control structure
- For increased safety: prevents localised operating errors
- Namur seating plane solenoid valve

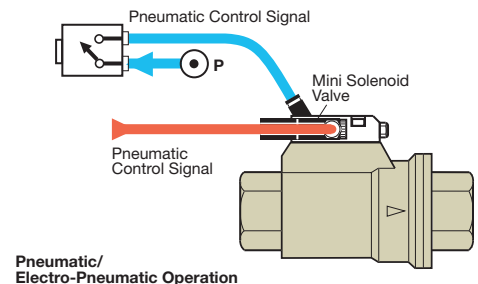

### 4203 Normally Closed, Double Female – NPT

PART NO.	C NPT	DN	F MM	G IN	H IN	H1 IN	L IN	LB.
4203 10 18 20	3/8	10	22	1.81	2.12	1.21	3.60	1.79
4203 15 22 20	1/2	15	27	2.03	2.33	1.31	4.13	2.39
4203 20 28 20	3/4	20	33	2.50	2.76	1.51	4.92	3.60
4203 25 35 20	1	25	41	2.72	2.99	1.63	5.31	4.46
4203 32 43 20	1 1/4	32	50	3.39	3.59	1.90	6.02	7.28
4203 40 50 20	1 1/2	40	60	3.78	4.01	2.12	6.67	9.22
4203 50 44 20	2	50	75	4.29	4.50	2.35	7.39	14.02

Pilot port: 1/8 - 27 NPT Complete with 1/8 NPT silencer

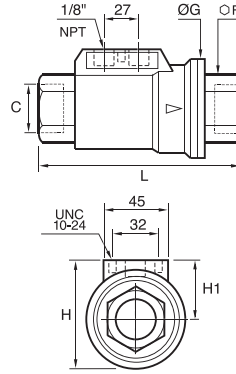

### 4202 Normally Closed, Double Female – BSPP

PART NO.	C BSPP	DN	F MM	G IN	H IN	H1 IN	L IN	KG.
4202 10 17 20	G3/8	10	22	46	54	31	98	.814
4202 15 21 20	G1/2	15	27	52	60	35	112	1.085
4202 20 27 20	G3/4	20	33	64	70	38	135	1.634
4202 25 34 20	G1	25	41	69	76	41.5	143	2.024
4202 32 42 20	G1 1/4	32	50	86	91	48	165	3.301
4202 40 49 20	G1 1/2	40	60	96	102	54	180	4.180
4202 50 48 20	G2	50	75	109	115	60.5	207	6.360

Pilot port: 1/8 BSPP Complete with 1/8 BSPT silencer

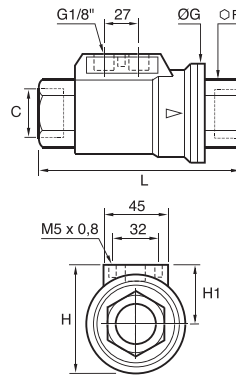

## Replacement Handles

	VALVE	PLATED STEEL LEVER W/COVER	S.S. LEVER (NO COVER)	S.S. LEVER W/COVER	TEE (NO COVER)	OVAL (W/COVER)	SHORT LEVER (NO COVER)	PLATED STEEL LKG. LEVER W/COVER	S.S. LOCKING LEVER W/COVER
V500P (501, 502, 506, 510, 590, 591)	-4	2560-10082	2566-00105		2566-00147	2566-00215	2566-00231	2560-10080	2560-10081
	-6	2560-10082	2566-00105		2566-00147	2566-00215	2566-00231	2560-10080	2560-10081
	-8	2560-10082	2566-00105		2566-00147	2566-00215	2566-00231	2560-10080	2560-10081
	-10	2560-10097	2566-00178		2566-00179			2566-10100	
	-12	2560-10097	2566-00178		2566-00179	2566-00180	—	2560-10100	2560-10101
	-16	2560-10097	2566-00178		2566-00179	2566-00180	—	2560-10100	2560-10101
	-20	2566-00143	2566-00153			—	2566-00142	2566-00135	—
	-24	2566-00143	2566-00153			—	2566-00142	2566-00135	—
V501SS & V502SS	-32	2566-00143	2566-00153			—	2566-00142	2566-00135	—
	-4	—		2566-00132	—	2566-00108	2566-00146	—	2566-00138
	-6	—		2566-00132	—	2566-00108	2566-00146	—	2566-00138
	-8	—		2566-00132	—	2566-00108	2566-00146	—	2566-00138
	-12	—		2566-00133	—	2566-00109	—	—	2566-00184
V502SS	-16	—		2566-00133	—	2566-00109	—	—	2566-00184
	-20	—		2566-00134	—		—	—	2566-00185
	-24	—		2566-00134	—		—	—	2566-00185
V500CS & V502CS	-32	—		2566-00134	—		—	—	2566-00185
	-4	2566-00158			2566-00170	2566-00166		2566-00162	
	-6	2566-00158			2566-00170	2566-00166		2566-00162	
	-8	2566-00158			2566-00171	2566-00166		2566-00162	
	-12	2566-00159			2566-00172	2566-00167		2566-00163	
	-16	2566-00159			2566-00172	2566-00167		2566-00163	
	-20	2566-00160				2566-00168		2566-00164	
V506CS	-24	2566-00160				2566-00168		2566-00164	
	-32	2566-00161				2566-00169		2566-00165	
	-4	2566-00158			2566-00170	2566-00166		2566-00162	
	-6	2566-00158			2566-00170	2566-00166		2566-00162	
	-8							2566-00234	
V533P	-12	—						2566-00235	
	-16	—						2566-00236	
	-4	2560-10152	2566-00105		2566-00147	2566-00215	2566-00231	2560-10160	
	-6	2560-10152	2566-00105		2566-00147	2566-00215	2566-00231	2560-10160	
	-8	2560-10152	2566-00105		2566-00147	2566-00215	2566-00231	2560-10160	
V520P	-12	2560-10153	2566-00178		2566-00179	2566-00180		2560-10168	
	-16	2560-10153	2566-00178		2566-00179	2566-00180		2560-10168	
	-4				2566-00277			2566-00262	
	-6				2566-00277			2566-00262	
	-8				2566-00277			2566-00262	
	-12				2566-00280			2566-00261	
	-16				2566-00280			2566-00261	
	-20	2566-00143	2566-00153					2566-00135	
	-24	2566-00143	2566-00153					2566-00135	
V500HP, V506HP, V507HP	-32	2566-00143	2566-00153					2566-00135	
	40	2566-00253							
	48	2566-00253							
	-4							BVHPLK-1 <sup>A</sup>	
	-6							BVHPLK-1 <sup>A</sup>	
	-8							BVHPLK-1 <sup>A</sup>	
	-12							BVHPLK-2 <sup>A</sup>	
-16							BVHPLK-2 <sup>A</sup>		
-20							BVHPLK-3 <sup>A</sup>		
-24							BVHPLK-3 <sup>A</sup>		
-32							BVHPLK-3 <sup>A</sup>		

<sup>A</sup> Locking kit for use with standard handles

### Replacement Handle Nuts

VALVE	PLATED STEEL	STAINLESS STEEL
V500P-4	2567-00020	2567-00023
V500P-6	2567-00020	2567-00023
V500P-8	2567-00020	2567-00023
V500P-12	2567-00055	2567-00057
V500P-16	2567-00055	2567-00057
V500P-20	2567-00051	2567-00052
V500P-24	2567-00051	2567-00052
V500P-32	2567-00051	2567-00052

### Replacement Handle Covers

VALVE	LEVER	SHORT LEVER	TEE
V500P-4	2569-00108	2569-00342	2569-00155
V500P-6	2569-00108	2569-00342	2569-00155
V500P-8	2569-00108	2569-00342	2569-00155
V500P-12	2569-00296		2569-00155
V500P-16	2569-00296		2569-00155
V500P-20	2569-00229	2569-00234	
V500P-24	2569-00229	2569-00234	
V500P-32	2569-00229	2569-00234	
V502SS-4		2569-00203	
V502SS-6		2569-00203	
V502SS-8		2569-00203	



<b>STX</b>	Stem Extension Kit
<b>P</b>	For use on Brass Ball Valves
<b>1</b>	1: 1/4" thru 1/2" valves 2: 3/4" thru 1" valves
<b>125</b>	125: 1-1/4" extension length 225: 2-1/4" extension length

<b>STX</b>	Stem Extension Kit
<b>SS</b>	For use on Stainless Steel Ball Valves
<b>1</b>	1: 1/4" thru 1/2" valves 2: 3/4" thru 1" valves 3: 1-1/4"-2" valves
<b>125</b>	125: 1-1/4" extension length 225: 2-1/4" extension length

All stem extension kit componentry is made from high quality, corrosion resistant stainless steel

Note: Stem extensions cannot be used with series 509 and series 520.

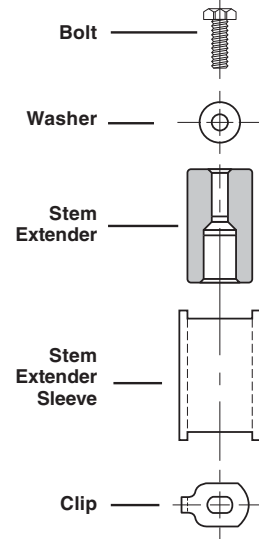

### Brass Valve Extension Dimensions STX-P-1-125

PART NO.	VALVE SIZE	B HEX	C HEX	H	L	M	N	D FLOW Ø
STX-P-1-125	1/4	15/16	15/16	3.96	4.96	2.03	3.73	.375
STX-P-1-125	3/8	15/16	15/16	3.96	4.96	2.03	3.73	.375
STX-P-1-125	1/2	1-1/16	1-1/16	3.96	5.05	2.20	3.84	.500
STX-P-2-125	3/4	1-1/4	1-5/16	3.96	5.25	2.42	4.06	.685
STX-P-2-125	1	1-1/2	1-9/16	3.96	5.89	2.75	4.33	.875

Note: Drawing shows STX-P assembled to XV500P series-not included

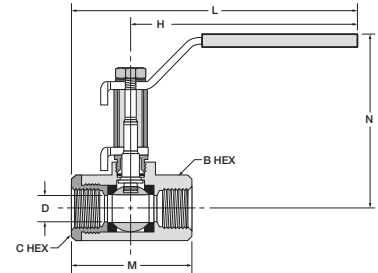

### Brass Valve Extension Dimensions STX-P-1-225

PART NO.	VALVE SIZE	B HEX	C HEX	H	L	M	N	D FLOW Ø
STX-P-1-225	1/4	15/16	15/16	3.96	4.96	2.03	4.73	.375
STX-P-1-225	3/8	15/16	15/16	3.96	4.96	2.03	4.73	.375
STX-P-1-225	1/2	1-1/16	1-1/16	3.96	5.05	2.20	4.84	.500
STX-P-2-225	3/4	1-1/4	1-5/16	3.96	5.25	2.42	5.06	.685
STX-P-2-225	1	1-1/2	1-9/16	3.96	5.89	2.75	5.33	.875

Note: Drawing shows STX-P assembled to XV500P series-not included

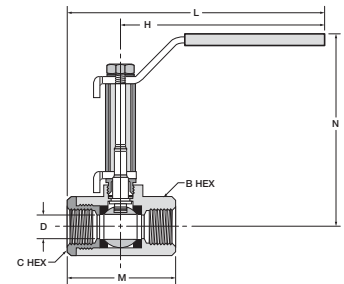

# Needle Valves



Parker's all brass needle valves have metal-to-metal seats with fine thread screwdown. The specially formulated low temperature seal remains elastic to temperatures as low as  $-40^{\circ}\text{F}$ .

## Product Features:

- Extruded Brass Body & Stem
- Low Temperature Seal
- Metal-to-Metal Seal
- Pin Handle

## Specifications:

### Pressure Range:

- Up to 150 psi

### Temperature Range

- $-40^{\circ}$  to  $+175^{\circ}\text{F}$
- Humidifier Valve Kit & Self Piercing  
Humidifier Kit:  $-30^{\circ}$  to  $+250^{\circ}\text{F}$
- NV311P/NV312P:  $0^{\circ}$  to  $+150^{\circ}\text{F}$

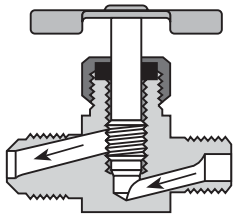
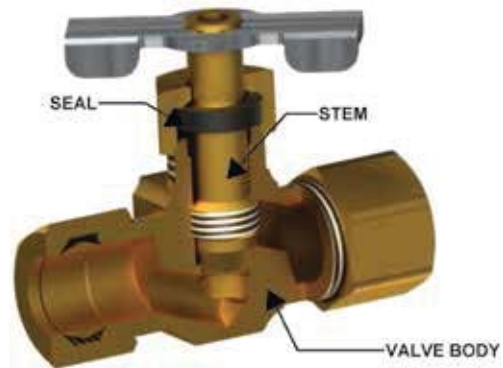

## Needle Valves Installation Instructions

Series NV valves should always be installed with the pressure against the seat. Refer to drawing to determine correct direction of flow.

### Angle Needle Valve NV101F

Flare to Male Pipe \* Provided with Pin Handle  
 Temperature Range: -45° to +250° F

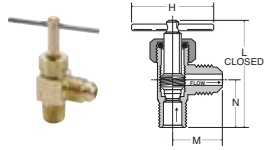

PART NO.	TUBE SIZE	PIPE THREAD	H	L	M	N
NV101F-4-2*	1/4	1/8	1.50	1.58	.75	.66
NV101F-6-4	3/8	1/4	1.38	1.86	.95	.90

### Needle Valve NV102F

Flare to Flare \*Provided with Pin Handle  
 Temperature Range: -45° to +250° F

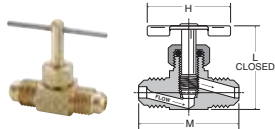

PART NO.	TUBE SIZE	H	L	M
NV102F-4*	1/4	1.50	1.34	1.50

### Needle Valve NV103F

Flare to Male Pipe \*Provided with Pin Handle  
 Temperature Range: -45° to +250° F

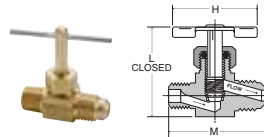

PART NO.	TUBE SIZE	PIPE THREAD	H	L	M
NV103F-4-2*	1/4	1/8	1.50	1.33	1.35

### Humidifier Valve HV104C

Temperature Range: -45° to +250° F

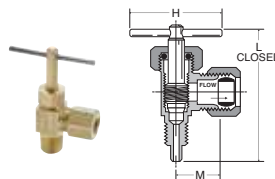

PART NO.	TUBE SIZE	PIPE THREAD	H	L	M
HV104C-4-2	1/4	1/8	1.50	1.89	.53

### Humidifier Valve clamp kit HV104C-kit

Temperature Range: -30° to +250° F  
 Clamp fits 3/8" O.D. through 1.315" O.D. tube or pipe.  
 Kit includes 60PT-4 and 63PT-4 for assembly with plastic or nylon tubing. For complete kit, specify entire part number as shown below:

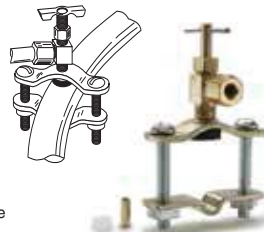

PART NO.	TUBE SIZE	PIPE THREAD
HV104C-4-2 KIT	1/4	1/8

### Self-Piercing Humidifier Valve clamp kit SPV104C-kit

Temperature Range: -30° to +250° F  
 Clamp fits 3/8" O.D. through 1.315" O.D. tube or pipe. Kit includes 60PT-4 and 63PT-4 for assembly with plastic or nylon tubing. For complete kit, specify entire part number as shown below:

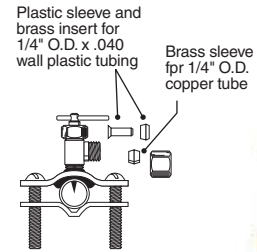

PART NO.	TUBE SIZE	PIPE THREAD
SPV104C KIT	1/4	1/8

### Angle Needle Valve NV104C-NV104CA

Compression to Male Pipe \*Provided with Pin Handle  
 Temperature Range: -45° to +250° F

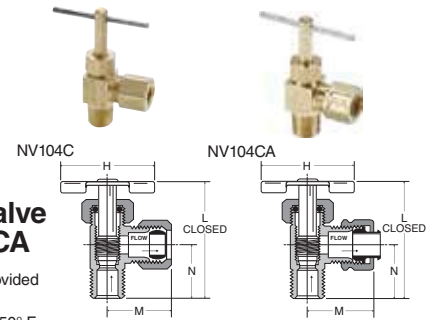

PART NO.	TUBE SIZE	PIPE THREAD	H	L	M	N
NV104C-4-2*	1/4	1/8	1.50	1.54	.88	.67
NV104CA-4-2*	1/4	1/8	1.50	1.49	.77	.66
NV104C-4-4	1/4	1/4	1.38	1.80	.93	.75
NV104C-5-2*	5/16	1/8	1.50	1.63	.88	.68
NV104C-6-4	3/8	1/4	1.38	1.76	.94	.81

### Needle Valve NV105C-NV105CA

Compression to Compression  
 \*Provided with Pin Handle  
 Temperature Range: -45° to +250° F

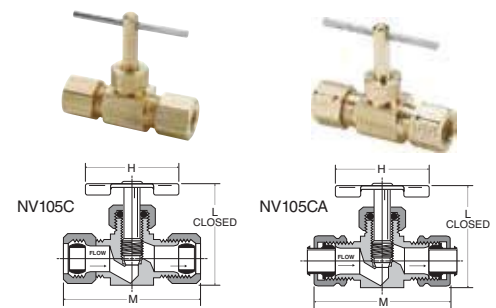

PART NO.	TUBE SIZE	H	L	M
NV105C-4*	1/4	1.50	1.41	1.75
NV105C-5*	5/16	1.50	1.35	1.73
NV105C-6	3/8	1.38	1.55	1.93
NV105CA-4*	1/4	1.50	1.41	1.64
NV105CA-6	3/8	1.38	1.55	1.78

### Needle Valve NV106C-NV106CA

Compression to Male Pipe  
 \*Provided with Pin Handle  
 Temperature Range: -45° to +250° F

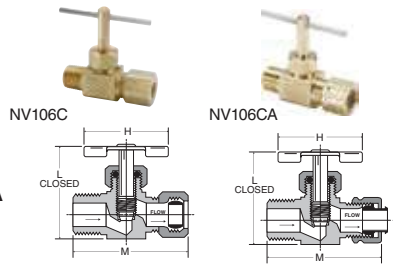

PART NO.	TUBE SIZE	PIPE THREAD	H	L	M
NV106C-4-2*	1/4	1/8	1.50	1.41	1.53
NV106C-4-4*	1/4	1/4	1.50	1.40	1.55
NV106C-5-2*	5/16	1/8	1.50	1.35	1.50
NV106C-6-4	3/8	1/4	1.38	1.56	1.75
NV106CA-4-2	1/4	1/8	1.50	1.41	1.47
NV106CA-4-4*	1/4	1/4	1.50	1.33	1.52
NV106CA-6-4	3/8	1/4	1.38	1.53	1.78

### Needle Valve NV107P

Male Pipe to Male Pipe  
 \*Provided with Pin Handle  
 Temperature Range: -45° to +250° F

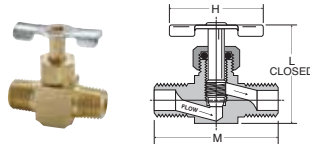

PART NO.	PIPE THREAD	H	L	M
NV107P-2*	1/8	1.50	1.35	1.25
NV107P-4	1/4	1.38	1.54	1.65

### Needle Valve NV108P

Female Pipe to Male Pipe  
 \*Provided with Pin Handle  
 Temperature Range: -45° to +250° F

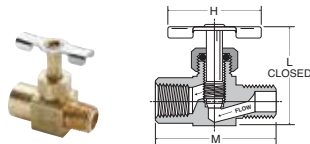

PART NO.	PIPE THREAD	H	L	M
NV108P-2*	1/8	1.50	1.36	1.25
NV108P-4	1/4	1.38	1.56	1.61

### Needle Valve NV109P

Female Pipe to Female Pipe  
 \*Provided with Pin Handle  
 Temperature Range: -45° to +250° F

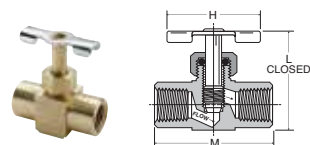

PART NO.	PIPE THREAD	H	L	M
NV109P-2*	1/8	1.50	1.35	1.25
NV109P-4	1/4	1.38	1.53	1.60

### Needle Valve NV311P

Poly-Tite to Male Pipe  
 Temperature Range: 0° to +150° F

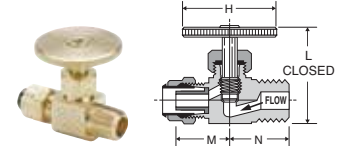

PART NO.	TUBE SIZE	PIPE THREAD	H	L	M	N
NV311P-4-2	1/4	1/8	1.07	1.17	.50	.63
NV311P-4-4	1/4	1/4	1.07	1.18	.50	.72
NV311P-6-4	3/8	1/4	1.07	1.19	.56	.72

### Angle Needle Valve NV312P

Poly-Tite to Male Pipe  
 Temperature Range: 0° to +150° F

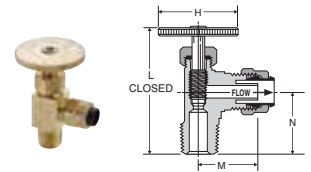

PART NO.	TUBE SIZE	PIPE THREAD	H	L	M	N
NV312P-4-2	1/4	1/8	1.07	1.53	.48	.68
NV312P-4-4	1/4	1/4	1.07	1.72	.56	.86
NV312P-6-4	3/8	1/4	1.07	1.68	.64	.86

# Drain Cocks/ Ground Plug Shutoff



Parker's ground plug shutoffs are manufactured from castings or forged bodies for extra strength. Hand tightening provides a metal-to-metal seal. Drain cocks are manufactured in both external and internal seats.

## Specifications:

### Pressure Range:

- Ground Plug Shutoff: 30 psi
- Drain Cocks: Up to 150 psi

### Temperature Range

- Ground Plug Shutoff: 32° to +125°F
- V406P/V407P: -40° to +180°F
- Drain Cocks: -65° to +250°F
- DCR601: -30° to +250°F



### Ground Plug Shutoff V203F

Flare to Flare  
Temperature Range: +32° to +125° F

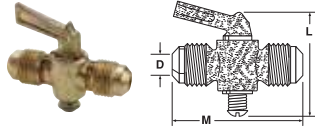

PART NO.	TUBE SIZE	L	M	FLOW DIA. D
V203F-6-6	3/8	2.26	2.13	.220
V203F-8-8	1/2	2.26	2.50	.281

### Ground Plug Shutoff V204F

Flare to Male Pipe  
Temperature Range: +32° to +125° F

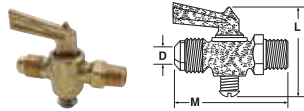

PART NO.	TUBE SIZE	PIPE THREAD	L	M	FLOW DIA. D
V204F-4-2	1/4	1/8	1.85	2.00	.188
V204F-6-4	3/8	1/4	1.85	2.18	.218

### Ground Plug Shutoff V303C / V303CA

Compression to Compression  
Temperature Range: +32° to +125° F

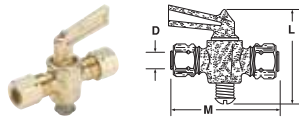

PART NO.	TUBE SIZE	L	M	FLOW DIA. D
V303C-4-4	1/4	1.88	2.33	.188
V303CA-4-4	1/4	1.90	1.75	.188
V303C-6-6	3/8	2.26	2.45	.218
V303CA-6-6	3/8	1.76	1.60	.218

### Ground Plug Shutoff V304C / V304CA

Compression to Male Pipe  
Temperature Range: +32° to +125° F

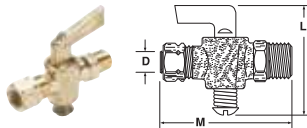

PART NO.	TUBE SIZE	PIPE THREAD	L	M	FLOW DIA. D
V304C-4-2	1/4	1/8	1.90	2.29	.188
V304CA-4-2	1/4	1/8	1.88	2.00	.188
V304C-4-4	1/4	1/4	1.90	2.15	.188
V304C-6-4	3/8	1/4	1.83	2.24	.218
V304CA-6-4	3/8	1/4	1.83	2.11	.218

### Ground Plug Shutoff V401P

Male Pipe to Male Pipe  
Temperature Range: +32° to +125° F

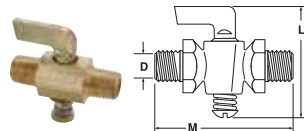

PART NO.	PIPE THREAD	L	M	FLOW DIA. D
V401P-2-2	1/8	1.90	2.25	.188
V401P-4-4	1/4	1.90	1.98	.188

### Ground Plug Shutoff V402P

Female Pipe to Male Pipe  
Temperature Range: +32° to +125° F

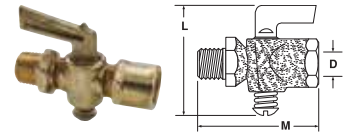

PART NO.	FEMALE PIPE THREAD	PIPE THREAD	L	M	FLOW DIA. D
V402P-2-2	1/8	1/8	1.85	1.78	.218
V402P-4-4	1/4	1/4	1.86	2.26	.218
V402P-6-6	3/8	3/8	2.34	2.21	.245

### Ground Plug Shutoff V403P

Female Pipe to Female Pipe  
Temperature Range: +32° to +125° F

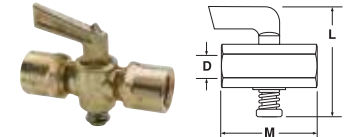

PART NO.	FEMALE PIPE THREAD	L	M	FLOW DIA. D
V403P-2-2	1/8	1.90	1.51	.218
V403P-4-4	1/4	1.90	1.65	.188
V403P-6-6*	3/8	2.25	2.00	.250

\*Made from extruded bar stock

### Three-way valve V406P

Female Pipe three ends  
Temperature Range: -40° to +180° F

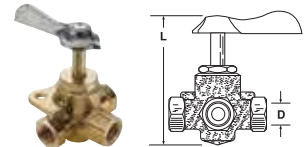

PART NO.	PIPE THREAD	L	FLOW DIA. D
V406P-4	1/4	3.10	.281

### Four-way valve V407P

Female Pipe four ends  
Temperature Range: -40° to +180° F

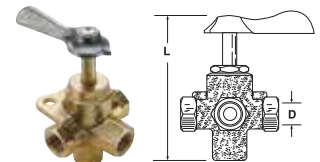

PART NO.	PIPE THREAD	L	FLOW DIA. D
V407P-4	1/4	3.30	.281

### Ground Plug Shutoff DC601

Temperature Range: +32° to +125° F

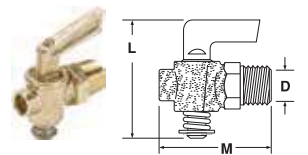

PART NO.	PIPE THREAD	L	M	FLOW DIA. D
DC601-2	1/8	1.90	1.40	.170
DC601-4	1/4	1.90	1.52	.170
DC601-6	3/8	2.26	1.74	.281
DC601-8	1/2	2.29	1.82	.281

### Drain Cock DCR601

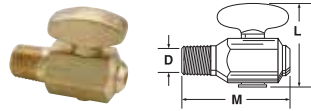

Temperature Range: -30° to +250° F

PART NO.	PIPE THREAD	L	M	FLOW DIA. D
DCR601-4	1/4	1.41	1.73	.156

### Internal Seal Drain Cock DC602

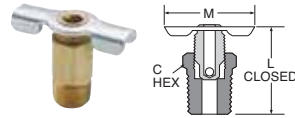

Temperature Range: -65° to +250° F

PART NO.	PIPE THREAD	C HEX	L	M
DC602-2	1/8	13/32	.92	1.25
DC602-4	1/4	9/16	.94	1.25

### Drain Cock DC603

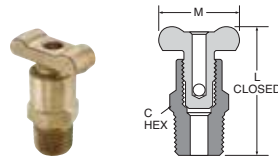

Temperature Range: -65° to +250° F

PART NO.	PIPE THREAD	C HEX	L	M
DC603-2	1/8	5/8	1.41	1.00
DC603-4	1/4	5/8	1.54	1.16
DC603-6	3/8	11/16	1.63	1.16

### External Seal Drain Cock DC604

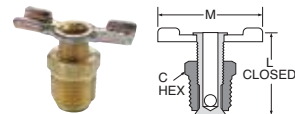

Temperature Range: -65° to +250° F

PART NO.	PIPE THREAD	C HEX	L	M
DC604-2*	1/8	7/16	.85	1.25
DC604-4	1/4	9/16	1.00	1.38
DC604-6*	3/8	11/16	1.22	1.68

\*When assembled handle wings are down facing

### External Seal Drain Cock DC606

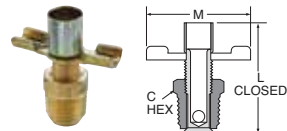

Temperature Range: -65° to +250° F

PART NO.	PIPE THREAD	C HEX	L	M
DC606-4	1/4-18	9/16	1.50	1.38

### Bib Drain Valve DC607

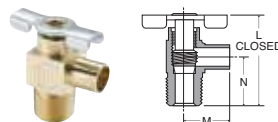

Temperature Range: -65° to +250° F

PART NO.	HOSE SIZE	PIPE THREAD	FLOW	L	M	N
DC607-4	3/8	1/4	.31	1.32	.67	.71